

FHP3132, FHP3232 Single and Dual, High-Speed, Rail-to-Rail Amplifiers

Features at ±5V

- 2.5mA supply current per amplifier
- 260MHz GBWP
- Stable for G = 5 and above
- Output voltage range at $R_L = 150\Omega$: $\pm 4.7V$
- Input includes negative rail
- 400V/ μs slew rate
- $\pm 100mA$ output current
- 17nV/ \sqrt{Hz} input voltage noise
- >100dB PSRR, CMRR, and open-loop gain
- FHP3132 lead-free package option (SOT23-5)
- FHP3232 lead-free package option (SOIC-8)
- RoHS compliant
- Fully specified at +3V, +5V, and $\pm 5V$ supplies

Applications

- A/D driver
- Active filters
- CCD imaging systems
- CD/DVD ROM
- Coaxial cable drivers
- Portable/battery-powered applications
- Twisted-pair driver
- Video driver

Description

The FHP3132 (single) and FHP3232 (dual) are low-cost, high-performance, voltage feedback amplifiers that consume only 2.5mA of supply current per channel, while providing $\pm 100mA$ of output current. These amplifiers are designed to operate from 2.7V to 12V ($\pm 6V$) supplies. The common-mode voltage range includes the negative rail and the output provides rail-to-rail performance.

The FHP3132 and FHP3232 are designed on a complementary bipolar process and provide 85MHz of bandwidth at $V_{OUT} = 2V_{pp}$ and gain of 5V/V. The combination of low power, rail-to-rail performance, low-voltage operation, and tiny package options make these amplifiers well suited for use in many general-purpose, high-speed applications.

Typical Application

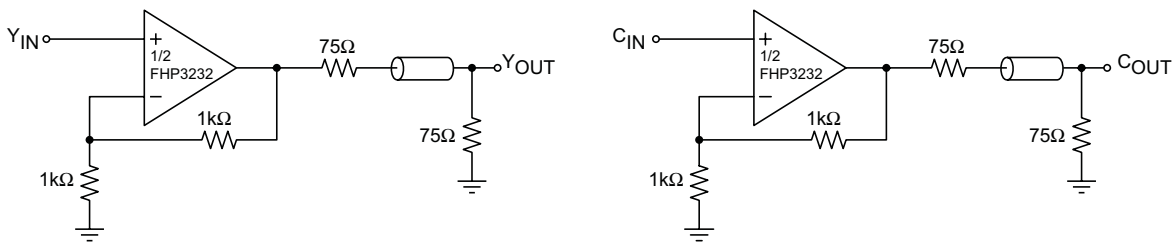

Figure 1. YC Video Line Driver

Ordering Information

Part Number	Package	Pb-Free	Operating Temperature Range	Packaging Method
FHP3132IS5X	SOT23-5	Yes	-40°C to +85°C	Reel
FHP3232IM8X	SOIC-8	Yes	-40°C to +85°C	Reel

Moisture sensitivity level for all parts is MSL-1.

Pin Configurations

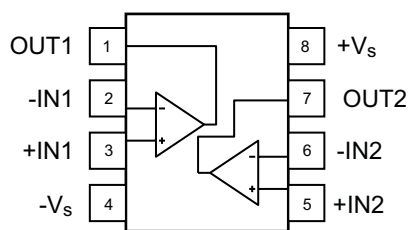

Figure 2. FHP3232 SOIC

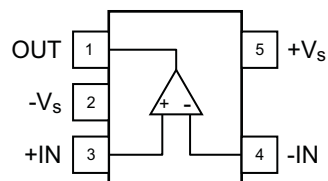

Figure 3. FHP3132 SOT23

Pin Assignments

FHP3232		
Pin # SOIC	Name	Description
1	OUT1	Output, channel 1
2	-IN1	Negative Input, channel 1
3	+IN1	Positive Input, channel 1
4	-Vs	Negative supply
5	+IN2	Positive Input, channel 2
6	-IN2	Negative Input, channel 2
7	OUT2	Output, channel 2
8	+Vs	Positive supply

FHP3132		
Pin # SOT23	Name	Description
1	OUT	Output
2	-Vs	Negative supply
3	+IN	Positive Input
4	-IN	Negative Input
5	+Vs	Positive supply

Absolute Maximum Ratings

Stresses exceeding the absolute maximum ratings may damage the device. The device may not function or be operable above the recommended operating conditions and stressing the parts to these levels is not recommended. In addition, extended exposure to stresses above the recommended operating conditions may affect device reliability. The absolute maximum ratings are stress ratings only.

Parameter	Min.	Max.	Unit
Supply Voltage	0	12.6	V
Input Voltage Range	$-V_S - 0.5V$	$+V_S + 0.5V$	V

Reliability Information

Parameter	Min.	Typ.	Max.	Unit
Junction Temperature			150	°C
Storage Temperature Range	-65		150	°C
Reflow Temperature (Soldering)			260	°C
Package Thermal Resistance	8-Lead SOIC ⁽¹⁾	155		°C/W
	5-Lead SOT23 ⁽¹⁾	296		°C/W

Notes:

1. Package thermal resistance (θ_{JA}), JEDEC standard, multi-layer test boards, still air.

ESD Protection

Product	FHP3132	FHP3232
Package	SOT23	SOIC
Human Body Model (HBM)	4.5kV	5kV
Charged Device Model (CDM)	2kV	2kV

Recommended Operating Conditions

The Recommended Operating Conditions table defines the conditions for actual device operation. Recommended operating conditions are specified to ensure optimal performance to the datasheet specifications. Fairchild does not recommend exceeding them or designing to absolute maximum ratings.

Parameter	Min.	Typ.	Max.	Unit
Operating Temperature Range	-40		+85	°C
Supply Voltage Range	2.7		12.0	V

Electrical Characteristics at +3V

$T_A = 25^\circ\text{C}$, $V_S = 3\text{V}$, $R_L = 2\text{k}\Omega$ to $V_S/2$, $G = 5$, $R_f = 1\text{k}\Omega$, unless otherwise noted.

Symbol	Parameter	Conditions	Min.	Typ.	Max.	Units
Frequency Domain Response						
BW_{SS}	Small Signal Bandwidth	$G = +5$, $V_{OUT} = 0.2V_{pp}$		95		MHz
BW_{LS}	Large Signal Bandwidth	$G = +5$, $V_{OUT} = 1V_{pp}$		70		MHz
GBWP	Gain Bandwidth Product	$G = +10$, $V_{OUT} = 0.2V_{pp}$		265		MHz
Time Domain Response						
t_R, t_F	Rise and Fall Time	$V_{OUT} = 0.2\text{V}$ step		5		ns
t_S	Settling Time to 0.1%	$V_{OUT} = 2\text{V}$ step		65		ns
OS	Overshoot	$V_{OUT} = 0.2\text{V}$ step		1		%
SR	Slew Rate	$V_{OUT} = 2\text{V}$ step, $G = -4$		400		V/ μs
Distortion/Noise Response						
HD2	2nd Harmonic Distortion	$V_{OUT} = 1V_{pp}$, 5MHz		70		dBc
HD3	3rd Harmonic Distortion	$V_{OUT} = 1V_{pp}$, 5MHz		84		dBc
THD	Total Harmonic Distortion	$V_{OUT} = 1V_{pp}$, 5MHz		68		dB
e_n	Input Voltage Noise	> 100kHz		17		nV/ $\sqrt{\text{Hz}}$
X_{TALK}	Crosstalk	FHP3232 at 1MHz		52		dB
DC Performance						
V_{IO}	Input Offset Voltage			1		mV
dV_{IO}	Average Drift			5		$\mu\text{V}/^\circ\text{C}$
I_b	Input Bias Current			-1.8		μA
dI_b	Average Drift			4		nA/ $^\circ\text{C}$
I_{IO}	Input Offset Current			0.01		μA
PSRR	Power Supply Rejection Ratio	DC		100		dB
A_{OL}	Open-Loop Gain	DC, $R_L = 150\Omega$		100		dB
I_S	Supply Current per Amplifier			2.5		mA
Input Characteristics						
R_{IN}	Input Resistance			500		k Ω
C_{IN}	Input Capacitance			1.5		pF
CMIR	Input Common Mode V Range			-0.3 to 2		V
CMRR	Common Mode Rejection Ratio	DC, $V_{CM} = 0\text{V}$ to $V_S - 1.5$		95		dB
Output Characteristics						
V_{OUT}	Output Voltage Swing	$R_L = 2\text{k}\Omega$ to $V_S/2$, $G = -1$		0.05 to 2.95		V
		$R_L = 150\Omega$ to $V_S/2$, $G = -1$		0.1 to 2.9		V
I_{OUT}	Linear Output Current			± 100		mA
I_{SC}	Short-Circuit Output Current	$V_{OUT} = V_S/2$		± 120		mA

Electrical Characteristics at +5V

$T_A = 25^\circ\text{C}$, $V_S = 5\text{V}$, $R_L = 2\text{k}\Omega$ to $V_S/2$, $G = 5$, $R_f = 1\text{k}\Omega$, unless otherwise noted.

Symbol	Parameter	Conditions	Min.	Typ.	Max.	Units
Frequency Domain Response						
BW_{SS}	Small Signal Bandwidth	$G = +5$, $V_{OUT} = 0.2V_{pp}$		90		MHz
BW_{LS}	Large Signal Bandwidth	$G = +5$, $V_{OUT} = 2V_{pp}$		75		MHz
GBWP	Gain Bandwidth Product	$G = +10$, $V_{OUT} = 0.2V_{pp}$		265		MHz
Time Domain Response						
t_R, t_F	Rise and Fall Time	$V_{OUT} = 0.2\text{V}$ step		5		ns
t_S	Settling Time to 0.1%	$V_{OUT} = 2\text{V}$ step		65		ns
OS	Overshoot	$V_{OUT} = 0.2\text{V}$ step		1		%
SR	Slew Rate	$V_{OUT} = 4\text{V}$ step, $G = -4$		400		V/ μs
Distortion / Noise Response						
HD2	2nd Harmonic Distortion	$V_{OUT} = 2V_{pp}$, 5MHz		58		dBc
HD3	3rd Harmonic Distortion	$V_{OUT} = 2V_{pp}$, 5MHz		80		dBc
THD	Total Harmonic Distortion	$V_{OUT} = 2V_{pp}$, 5MHz		56		dB
e_n	Input Voltage Noise	> 100kHz		17		nV/ $\sqrt{\text{Hz}}$
X_{TALK}	Crosstalk	FHP3232 at 1MHz		52		dB
DC Performance						
V_{IO}	Input Offset Voltage			1		mV
dV_{IO}	Average Drift			5		$\mu\text{V}/^\circ\text{C}$
I_b	Input Bias Current			-1.8		μA
dI_b	Average Drift			4		nA/ $^\circ\text{C}$
I_{IO}	Input Offset Current			0.01		μA
PSRR	Power Supply Rejection Ratio	DC		100		dB
A_{OL}	Open-Loop Gain	DC, $R_L = 150\Omega$		100		dB
I_S	Supply Current per Amplifier			2.5		mA
Input Characteristics						
R_{IN}	Input Resistance			500		k Ω
C_{IN}	Input Capacitance			1.5		pF
CMIR	Input Common Mode V Range			-0.3 to 4		V
CMRR	Common Mode Rejection Ratio	DC, $V_{CM} = 0\text{V}$ to $V_S - 1.5$		95		dB
Output Characteristics						
V_{OUT}	Output Voltage Swing	$R_L = 2\text{k}\Omega$ to $V_S/2$		0.05 to 4.95		V
		$R_L = 150\Omega$ to $V_S/2$		0.1 to 4.9		V
I_{OUT}	Linear Output Current			± 100		mA
I_{SC}	Short-Circuit Output Current	$V_{OUT} = V_S/2$		± 120		mA

Electrical Characteristics at $\pm 5V$

$T_A = 25^\circ C$, $V_S = \pm 5V$, $R_L = 2k\Omega$ to GND, $G = 5$, $R_f = 1k\Omega$, unless otherwise noted.

Symbol	Parameter	Conditions	Min.	Typ.	Max.	Units
Frequency Domain Response						
BW_{SS}	Small Signal Bandwidth	$G = +5$, $V_{OUT} = 0.2V_{pp}$		85		MHz
BW_{LS}	Large Signal Bandwidth	$G = +5$, $V_{OUT} = 2V_{pp}$		70		MHz
GBWP	Gain Bandwidth Product	$G = +10$, $V_{OUT} = 0.2V_{pp}$		260		MHz
Time Domain Response						
t_R, t_F	Rise and Fall Time	$V_{OUT} = 0.2V$ step		6		ns
t_S	Settling Time to 0.1%	$V_{OUT} = 2V$ step		55		ns
OS	Overshoot	$V_{OUT} = 0.2V$ step		1		%
SR	Slew Rate	$V_{OUT} = 4V$ step, $G = -4$		400		V/ μs
Distortion/Noise Response						
HD2	2nd Harmonic Distortion	$V_{OUT} = 2V_{pp}$, 5MHz		56		dBc
HD3	3rd Harmonic Distortion	$V_{OUT} = 2V_{pp}$, 5MHz		90		dBc
THD	Total Harmonic Distortion	$V_{OUT} = 2V_{pp}$, 5MHz		55		dB
e_n	Input Voltage Noise	> 100kHz		17		nV/ \sqrt{Hz}
X_{TALK}	Crosstalk	FHP3232 at 1MHz		52		dB
DC Performance						
V_{IO}	Input Offset Voltage ⁽¹⁾		-6	1	6	mV
dV_{IO}	Average Drift			5		$\mu V/^\circ C$
I_b	Input Bias Current ⁽¹⁾		-4.0	-1.8		μA
dI_b	Average Drift			4		nA/ $^\circ C$
I_{IO}	Input Offset Current ⁽¹⁾		-0.80	0.01	0.80	μA
PSRR	Power Supply Rejection Ratio ⁽²⁾	DC	80	100		dB
A_{OL}	Open-Loop Gain ⁽²⁾	DC, $R_L = 150\Omega$	80	100		dB
I_S	Supply Current per Amplifier ⁽¹⁾			2.5	3.5	mA
Input Characteristics						
R_{IN}	Input Resistance			500		k Ω
C_{IN}	Input Capacitance			1.5		pF
CMIR	Input Common Mode V Range			-5.3 to 4.0		V
CMRR	Common Mode Rejection Ratio ⁽²⁾	DC, $V_{CM} = -5V$ to 3.5V	75	100		dB
Output Characteristics						
V_{OUT}	Output Voltage Swing	$R_L = 2k\Omega$		± 4.95		V
		$R_L = 150\Omega^{(1)}$	-4.65	± 4.70	4.65	V
I_{OUT}	Linear Output Current			± 100		mA
I_{SC}	Short-Circuit Output Current	$V_{OUT} = 0V$		± 120		mA

Notes:

- 100% tested at 25°C.
- Minimum and maximum values are guaranteed by design/characterization.

Typical Performance Characteristics

$T_A = 25^\circ\text{C}$, $V_S = \pm 5\text{V}$, $R_L = 2\text{k}\Omega$ to GND, $G = 5$, $R_f = 1\text{k}\Omega$, unless otherwise noted.

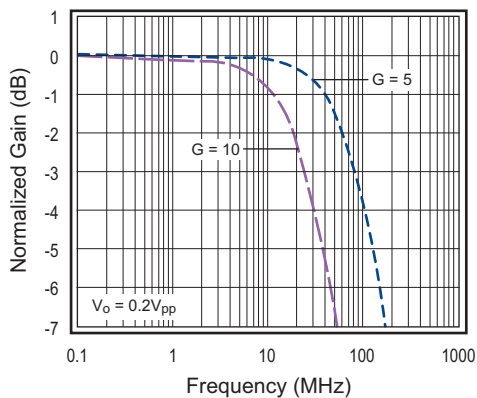

Figure 4. Non-Inverting Freq. Response ($\pm 5\text{V}$)

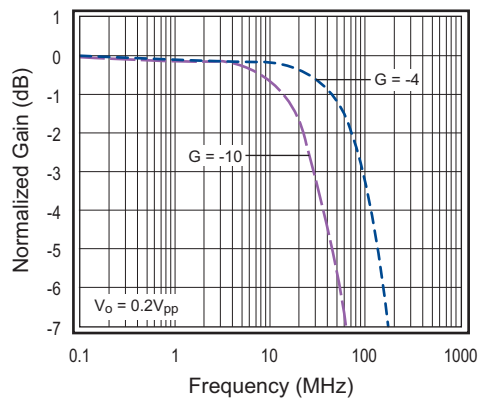

Figure 5. Inverting Freq. Response ($\pm 5\text{V}$)

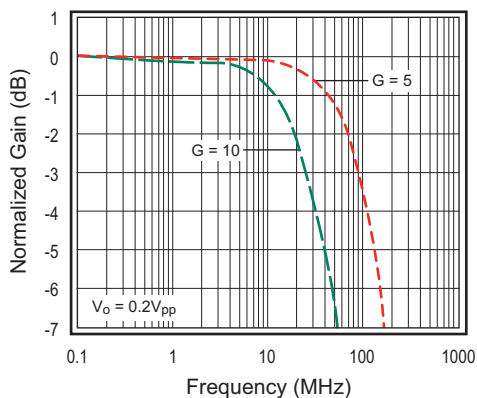

Figure 6. Non-Inverting Freq. Response (5V)

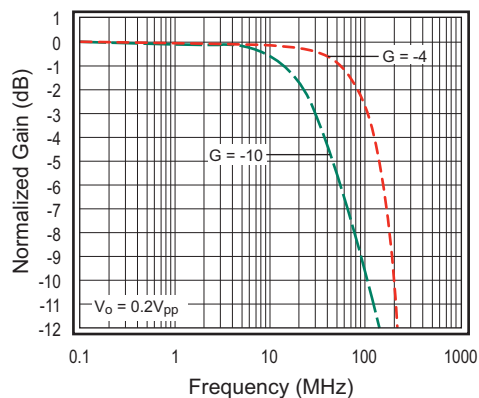

Figure 7. Inverting Freq. Response (5V)

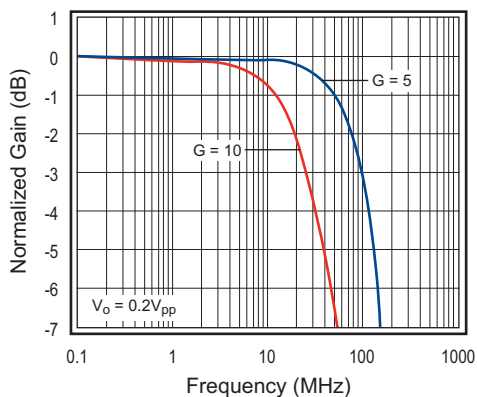

Figure 8. Non-Inverting Freq. Response (3V)

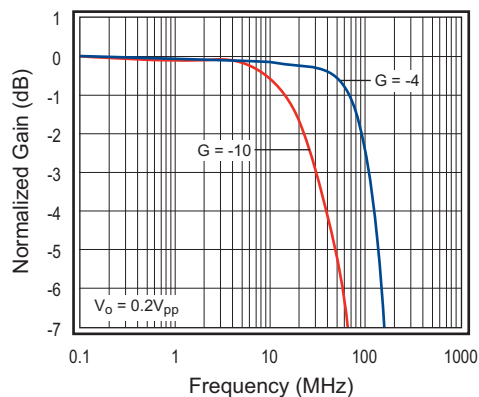

Figure 9. Inverting Freq. Response (3V)

Typical Performance Characteristics (Continued)

$T_A = 25^\circ\text{C}$, $V_S = \pm 5\text{V}$, $R_L = 2\text{k}\Omega$ to GND, $G = 5$, $R_I = 1\text{k}\Omega$, unless otherwise noted.

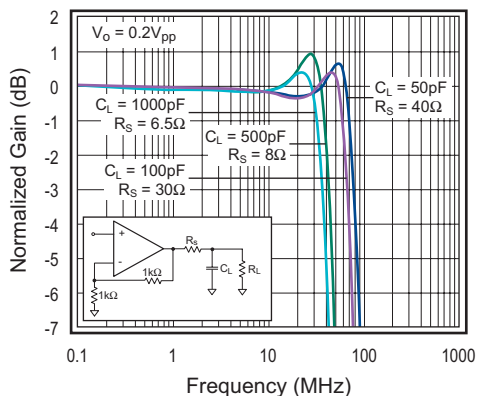

Figure 10. Frequency Response vs. C_L (3V)

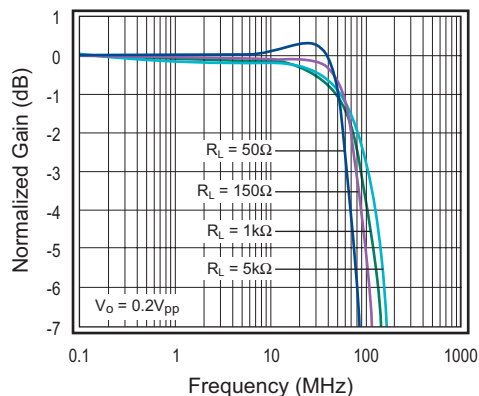

Figure 11. Frequency Response vs. R_L (3V)

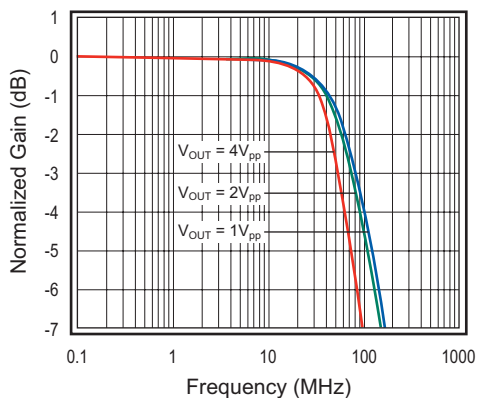

Figure 12. Large Signal Freq. Response (5V)

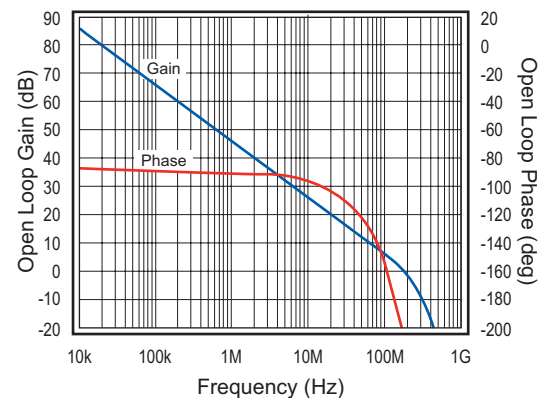

Figure 13. Open-Loop Gain and Phase (5V)

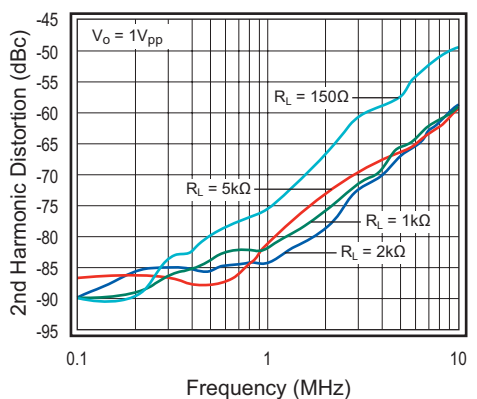

Figure 14. HD2 vs. R_L (3V)

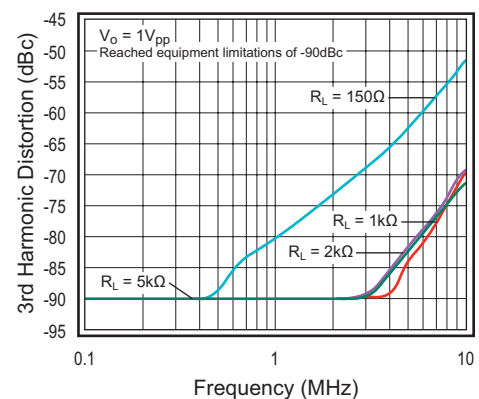

Figure 15. HD3 vs. R_L (3V)

Typical Performance Characteristics (Continued)

$T_A = 25^\circ\text{C}$, $V_S = \pm 5\text{V}$, $R_L = 2\text{k}\Omega$ to GND, $G = 5$, $R_I = 1\text{k}\Omega$, unless otherwise noted.

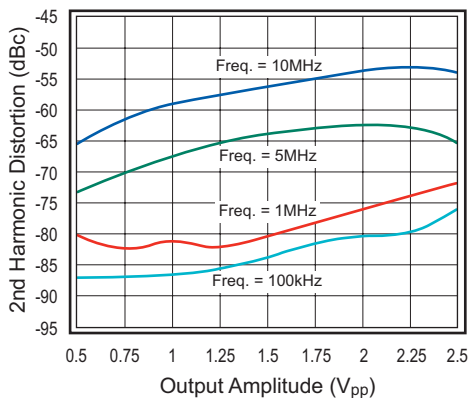

Figure 16. HD2 vs. V_{OUT} (3V)

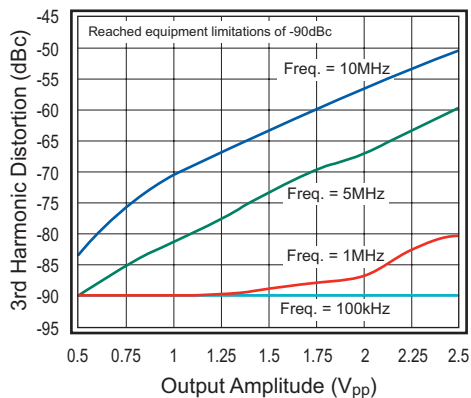

Figure 17. HD3 vs. V_{OUT} (3V)

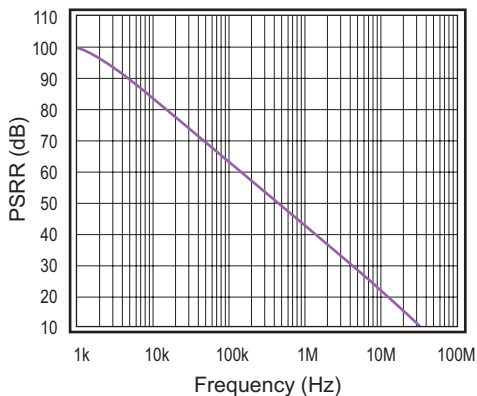

Figure 18. PSRR vs. Frequency (3V)

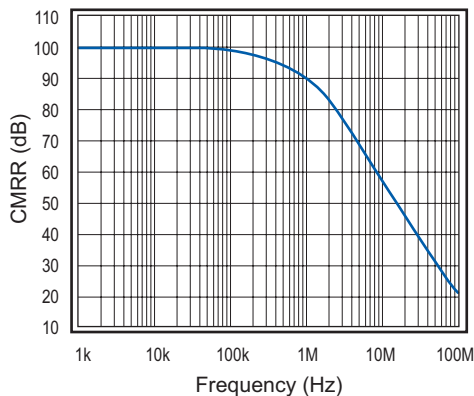

Figure 19. CMRR vs. Frequency (3V)

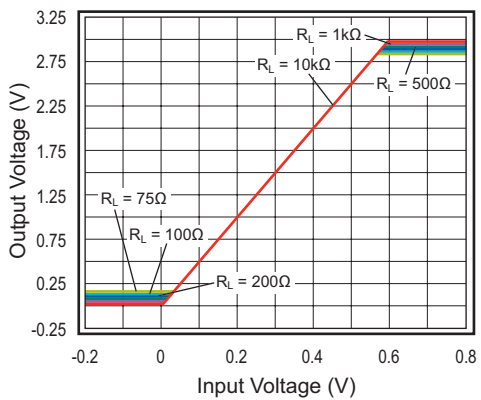

Figure 20. Output Voltage Swing vs. Load (3V)

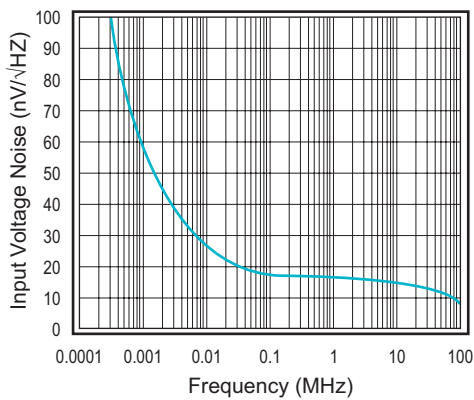

Figure 21. Input Voltage Noise (3V)

Typical Performance Characteristics (Continued)

$T_A = 25^\circ\text{C}$, $V_S = \pm 5\text{V}$, $R_L = 2\text{k}\Omega$ to GND, $G = 5$, $R_f = 1\text{k}\Omega$, unless otherwise noted.

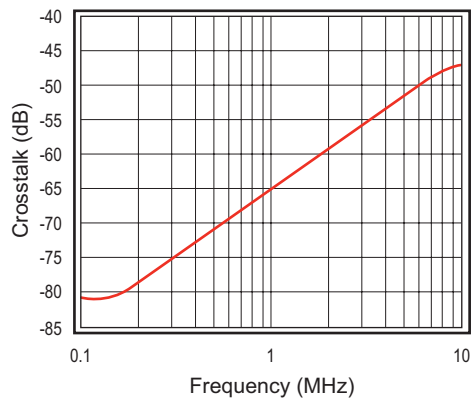

Figure 22. Crosstalk vs. Frequency (3V)

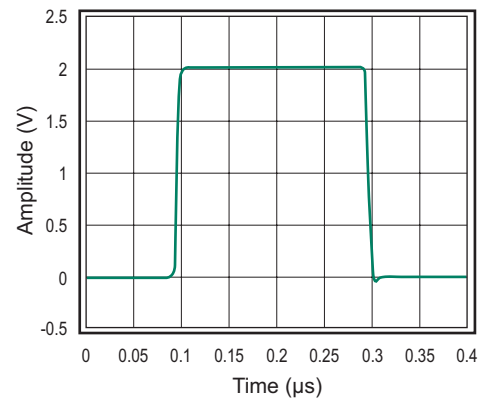

Figure 23. Pulse Response (3V)

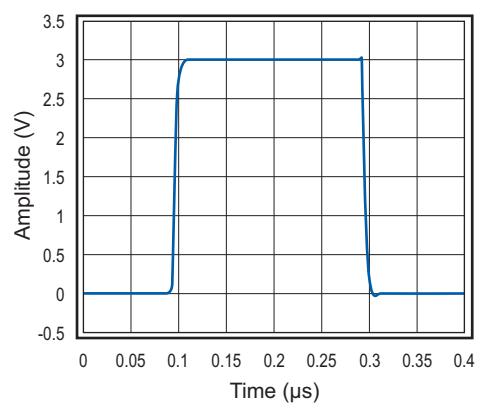

Figure 24. Pulse Response (5V)

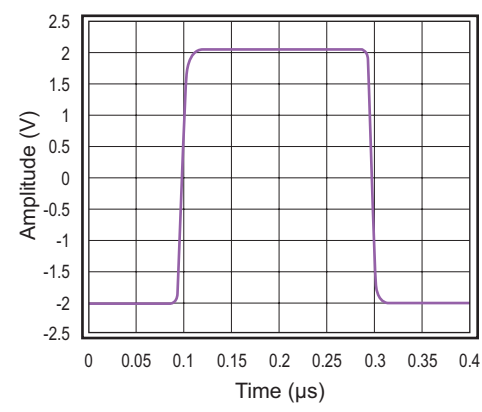

Figure 25. Pulse Response (±5V)

Application Information

Driving Capacitive Loads

The Frequency Response vs. C_L plot in Figure 10 illustrates the response of the FHP3132/3232. A small series resistance (R_s) at the output of the amplifier, illustrated in Figure 26, improves stability and settling performance. R_s values in the Frequency Response vs. C_L plot were chosen to achieve maximum bandwidth with less than 1dB of peaking. For maximum flatness, use a larger R_s .

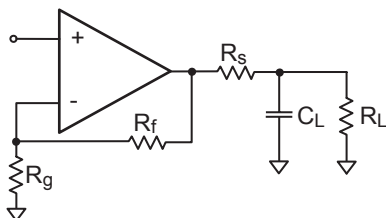

Figure 26. Typical Topology for Driving Capacitive Loads

Power Dissipation

The maximum internal power dissipation allowed is directly related to the maximum junction temperature. If the maximum junction temperature exceeds 150°C for an extended time, device failure may occur.

The FHP3132 and FHP3232 are short-circuit protected; however, this may not guarantee that the maximum junction temperature (+150°C) is not exceeded under all conditions. RMS power dissipation can be calculated using the following equation:

$$P_D = I_s * (V_{s+} - V_{s-}) + (V_{s+} - V_{o(RMS)}) * I_{OUT(RMS)} \quad \text{EQ. 1}$$

where:

I_s = the supply current

V_{s+} = the positive supply pin voltage

V_{s-} = the negative supply pin voltage

$V_{o(RMS)}$ = the RMS output voltage

$I_{OUT(RMS)}$ = the RMS output current delivered to the load.

Follow the maximum power derating curves shown in Figure 27 to ensure proper operation.

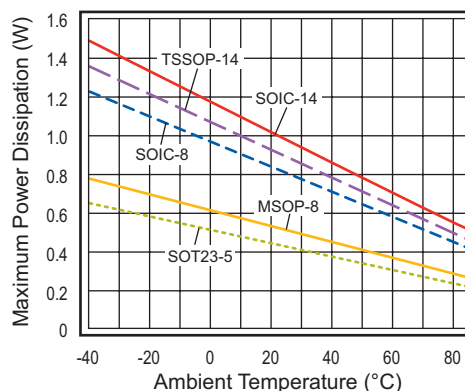

Figure 27. Maximum Power Derating

Overdrive Recovery

For an amplifier, an overdrive condition occurs when the output and/or input ranges are exceeded. The recovery time varies based on whether the input or output is overdriven and by how much the ranges are exceeded. The FHP3132/3232 typically recovers in less than 50ns from an overdrive condition. Figure 28 shows the FHP3132 in an overdriven condition.

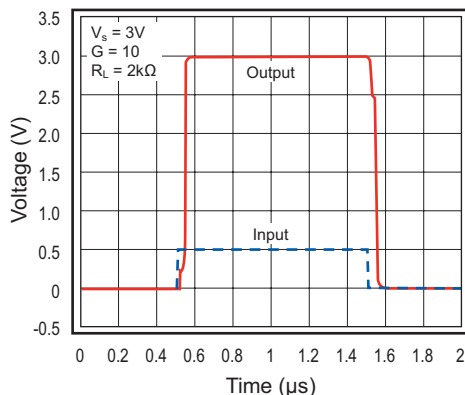

Figure 28. Overdrive Recovery

Layout Considerations

General layout and supply bypassing play major roles in high-frequency performance. Fairchild has evaluation boards to guide high-frequency layout and aid device testing and characterization. Follow the guidelines below as a basis for high-frequency layout:

- Include 6.8 μ F and 0.01 μ F ceramic capacitors.
- Place the 6.8 μ F capacitor within 0.75 inches of the power pin.
- Place the 0.01 μ F capacitor within 0.1 inches of the power pin.
- Remove the ground plane under and around the part, especially near the input and output pins, to reduce parasitic capacitance.
- Minimize all trace lengths to reduce series inductances.

Refer to the evaluation board layouts shown below for more information.

Evaluation Board Information

The following evaluation boards are available to aid testing and layout of these devices:

Evaluation Board	Products
KEB002	FHP3132IS5X
KEB003	FHP3232IM8X

Evaluation Board Schematics

Evaluation board schematics and layouts are shown in the figures below. These evaluation boards are built for dual-supply operation. Follow these steps to use the board in a single-supply application:

1. Short $-V_s$ to ground.
2. Use C3 and C4 if the $-V_s$ pin of the amplifier is not directly connected to the ground plane.

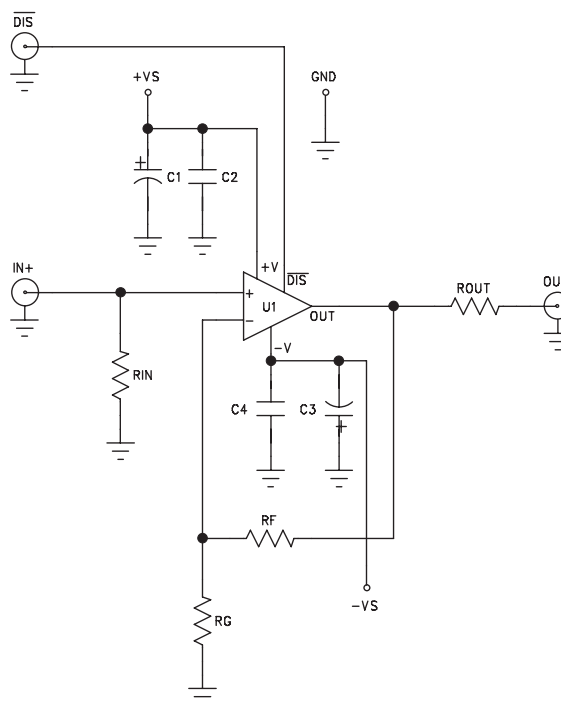

Figure 29. FHP3130 KEB002/KEB003 Schematic

Evaluation Board Layouts

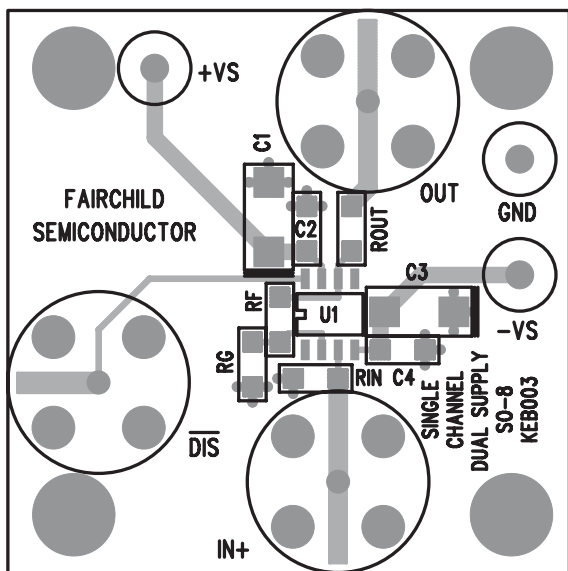

Figure 30. FHP3132 KEB002 (Top-Side)

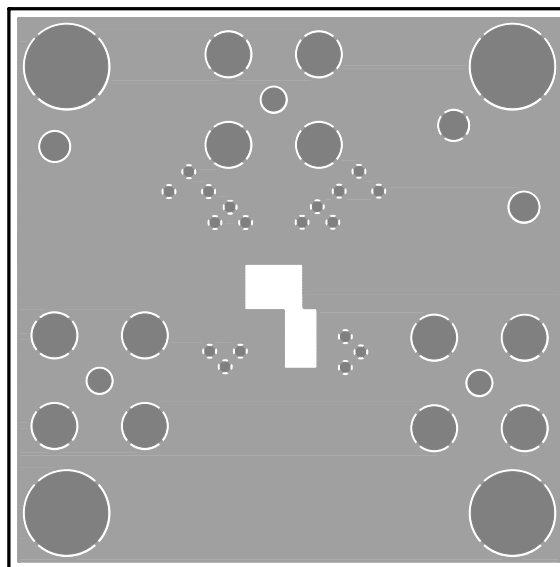

Figure 31. FHP3232 KEB003 (Top-Side)

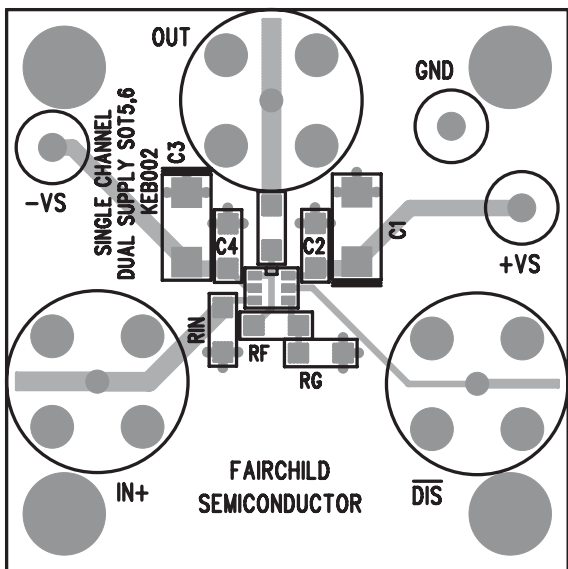

Figure 32. FHP3132 KEB002 (Bottom-Side)

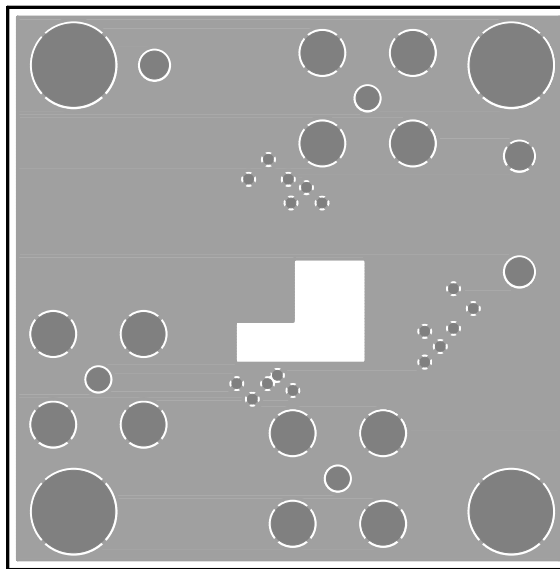

Figure 33. FHP3232 KEB003 (Bottom-Side)

Mechanical Dimensions

Dimensions are in millimeters unless otherwise noted.

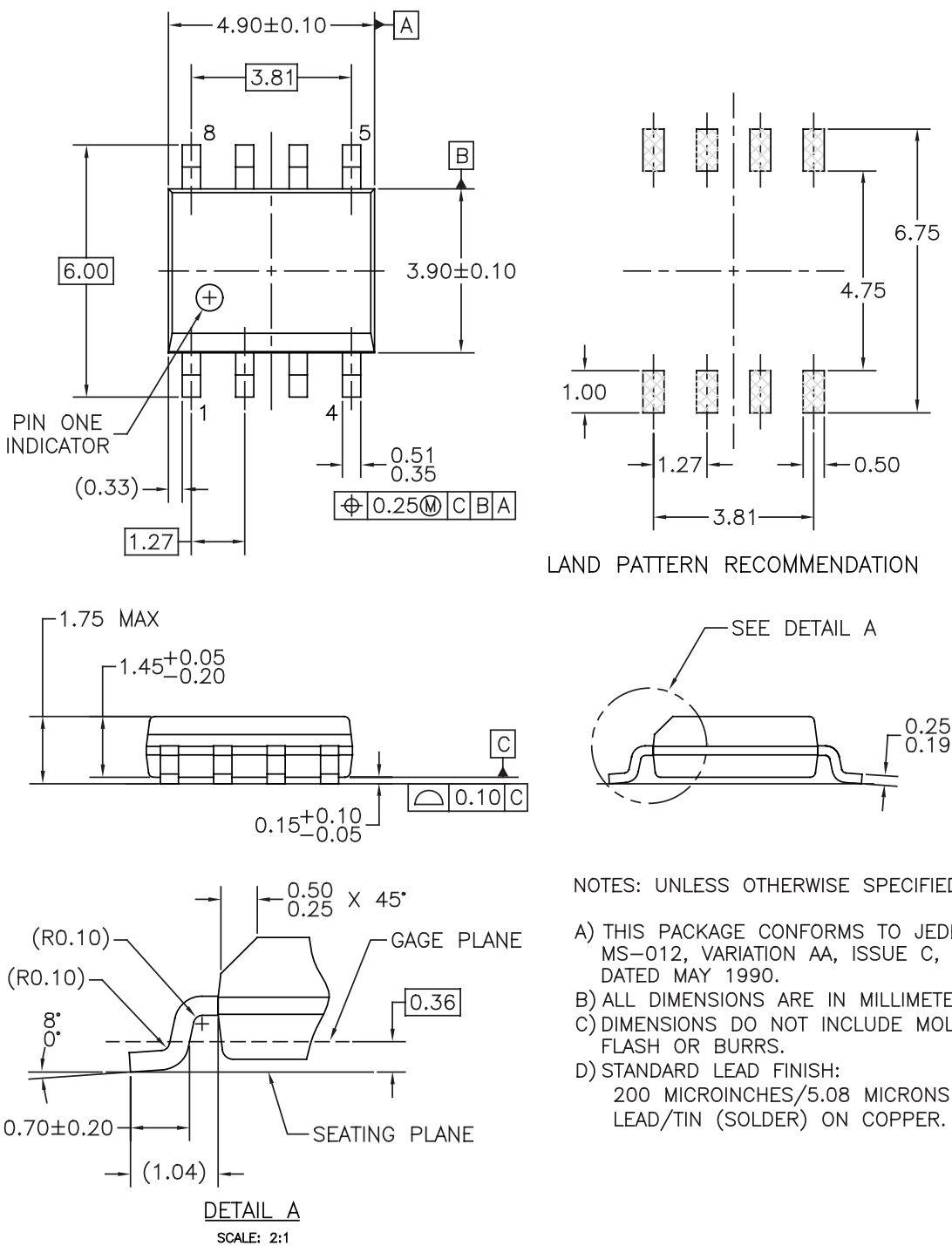
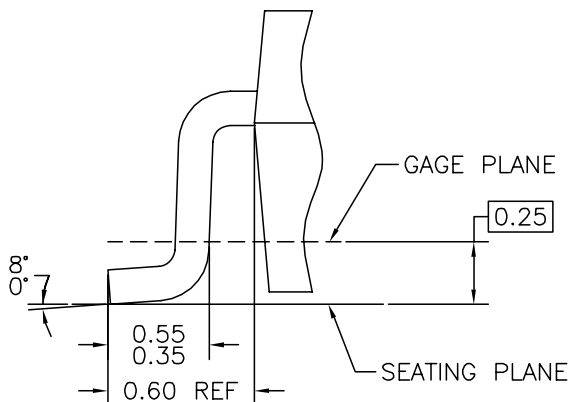
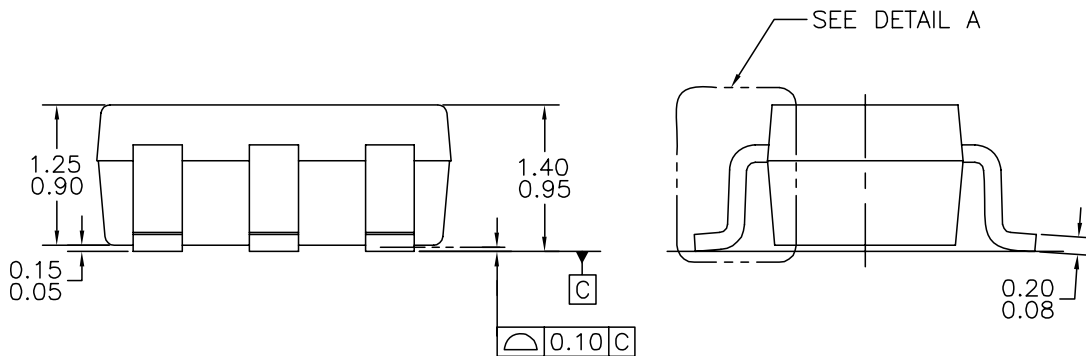
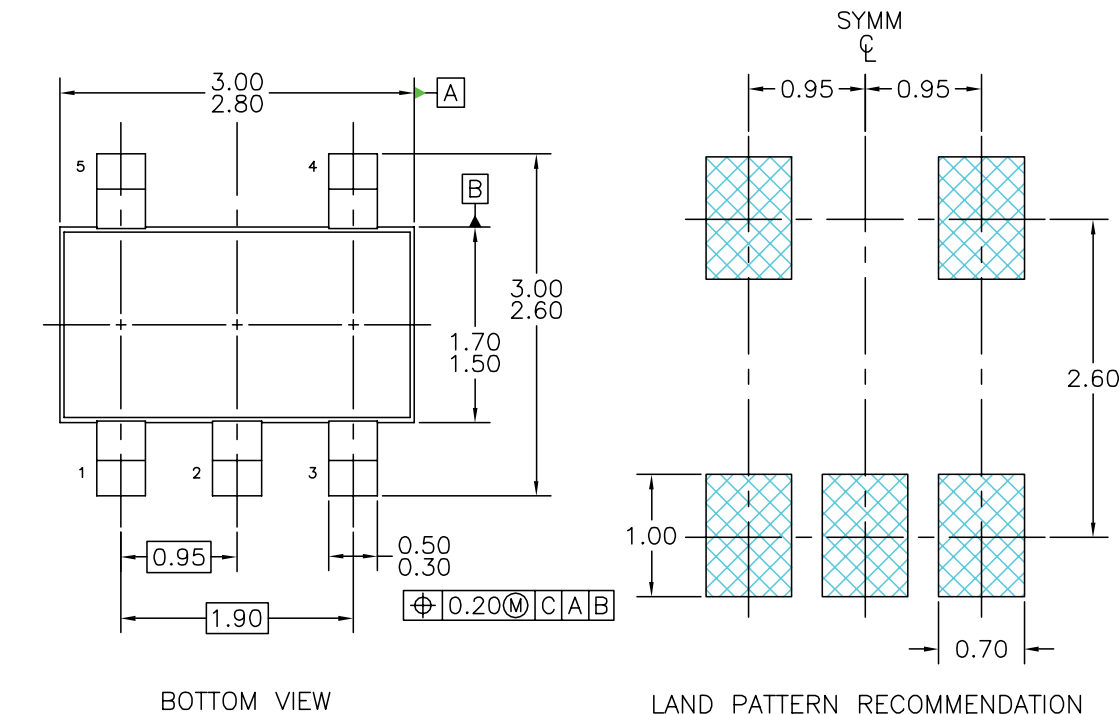

Figure 34. SOIC-8 Package

Mechanical Dimensions

Dimensions are in millimeters unless otherwise noted.



MA05BrevC

NOTES: UNLESS OTHERWISE SPECIFIED

- A) THIS PACKAGE CONFORMS TO JEDEC MO-178, ISSUE B, VARIATION AA, DATED JANUARY 1999.
- B) ALL DIMENSIONS ARE IN MILLIMETERS.

Figure 35. SOT23-5 Package



TRADEMARKS

The following are registered and unregistered trademarks Fairchild Semiconductor owns or is authorized to use and is not intended to be an exhaustive list of all such trademarks.

ACEx [®]	HiSeC [™]	Programmable Active Droop [™]	TinyLogic [®]
Across the board. Around the world. [™]	<i>i-Lo</i> [™]	QFET [®]	TINYOPTO [™]
ActiveArray [™]	ImpliedDisconnect [™]	QS [™]	TinyPower [™]
Bottomless [™]	IntelliMAX [™]	QT Optoelectronics [™]	TinyWire [™]
Build it Now [™]	ISOPLANAR [™]	Quiet Series [™]	TruTranslation [™]
CoolFET [™]	MICROCOUPLER [™]	RapidConfigure [™]	μSerDes [™]
CROSSVOLT [™]	MicroPak [™]	RapidConnect [™]	UHC [®]
CTL [™]	MICROWIRE [™]	ScalarPump [™]	UniFET [™]
Current Transfer Logic [™]	MSX [™]	SMART START [™]	VCX [™]
DOME [™]	MSXPro [™]	SPM [®]	Wire [™]
E ² CMOS [™]	OCC [™]	STEALTH [™]	
EcoSPARK [®]	OCCPro [™]	SuperFET [™]	
EnSigna [™]	OPTOLOGIC [®]	SuperSOT [™] -3	
FACT Quiet Series [™]	OPTOPLANAR [®]	SuperSOT [™] -6	
FACT [®]	PACMAN [™]	SuperSOT [™] -8	
FAST [®]	POP [™]	SyncFET [™]	
FASTr [™]	Power220 [®]	TCM [™]	
FPS [™]	Power247 [®]	The Power Franchise [®]	
FRFET [®]	PowerEdge [™]	 ™	
GlobalOptoisolator [™]	PowerSaver [™]	TinyBoost [™]	
GTO [™]	PowerTrench [®]	TinyBuck [™]	

DISCLAIMER

FAIRCHILD SEMICONDUCTOR RESERVES THE RIGHT TO MAKE CHANGES WITHOUT FURTHER NOTICE TO ANY PRODUCTS HEREIN TO IMPROVE RELIABILITY, FUNCTION OR DESIGN. FAIRCHILD DOES NOT ASSUME ANY LIABILITY ARISING OUT OF THE APPLICATION OR USE OF ANY PRODUCT OR CIRCUIT DESCRIBED HEREIN; NEITHER DOES IT CONVEY ANY LICENSE UNDER ITS PATENT RIGHTS, NOR THE RIGHTS OF OTHERS. THESE SPECIFICATIONS DO NOT EXPAND THE TERMS OF FAIRCHILD'S WORLDWIDE TERMS AND CONDITIONS, SPECIFICALLY THE WARRANTY THEREIN, WHICH COVERS THESE PRODUCTS.

LIFE SUPPORT POLICY

FAIRCHILD'S PRODUCTS ARE NOT AUTHORIZED FOR USE AS CRITICAL COMPONENTS IN LIFE SUPPORT DEVICES OR SYSTEMS WITHOUT THE EXPRESS WRITTEN APPROVAL OF FAIRCHILD SEMICONDUCTOR CORPORATION.

As used herein:

1. Life support devices or systems are devices or systems which, (a) are intended for surgical implant into the body or (b) support or sustain life, and (c) whose failure to perform when properly used in accordance with instructions for use provided in the labeling, can be reasonably expected to result in a significant injury of the user.
2. A critical component in any component of a life support, device, or system whose failure to perform can be reasonably expected to cause the failure of the life support device or system, or to affect its safety or effectiveness.

PRODUCT STATUS DEFINITIONS

Definition of Terms

Datasheet Identification	Product Status	Definition
Advance Information	Formative or In Design	This datasheet contains the design specifications for product development. Specifications may change in any manner without notice.
Preliminary	First Production	This datasheet contains preliminary data; supplementary data will be published at a later date. Fairchild Semiconductor reserves the right to make changes at any time without notice to improve design.
No Identification Needed	Full Production	This datasheet contains final specifications. Fairchild Semiconductor reserves the right to make changes at any time without notice to improve design.
Obsolete	Not In Production	This datasheet contains specifications on a product that has been discontinued by Fairchild Semiconductor. The datasheet is printed for reference information only.

Rev. I24