

C2012NP02W331J060AA

TDK Item Description : C2012NP02W331JT****



Application & Main Feature

Commercial Grade (Mid Voltage (100 to 630V))

Series

C2012 [EIA CC0805]

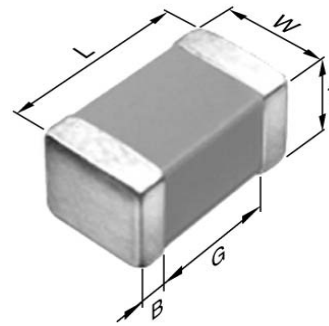

Dimensions

L 2.00mm +/-0.2mm
 W 1.25mm +/-0.2mm
 T 0.60mm +/-0.15mm
 B 0.20mm Min.
 G

Temperature Characteristic

NP0 (-55 to 150 degC 0+/-30ppm/degC)

Rated Voltage

2W (450Vdc)

Capacitance

330pF

Capacitance Tolerance

J (+/-5%)

Q Factor

1000 Min.

Insulation Resistance

10Gohm Min.

AEC-Q200

Not Applicable

|Z|, ESR vs. Freq. Characteristics

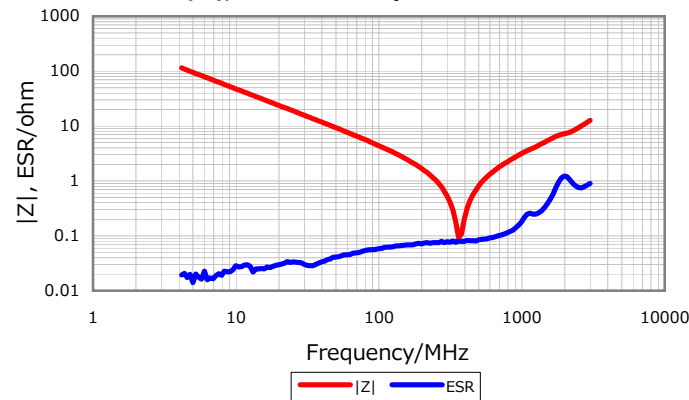

DC Bias Characteristic

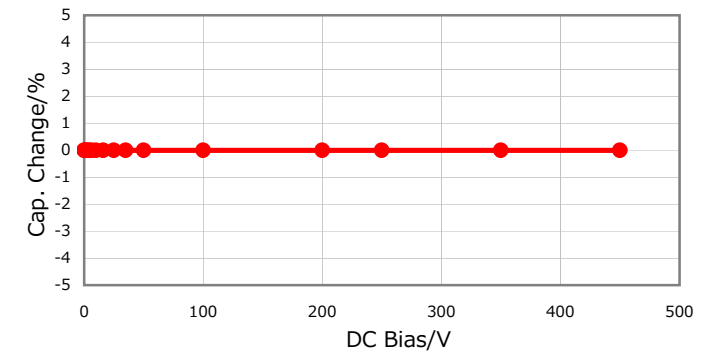

Cap. vs. Freq. Characteristic

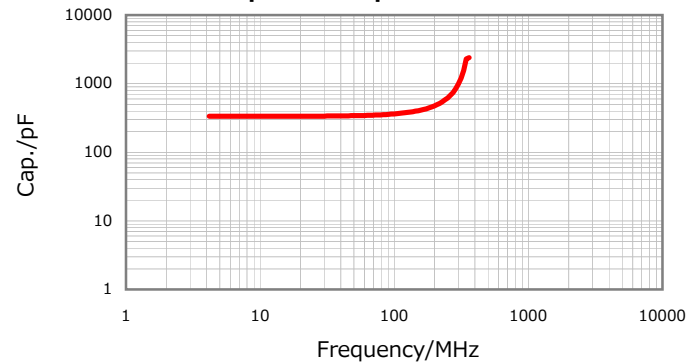

Temperature Characteristics

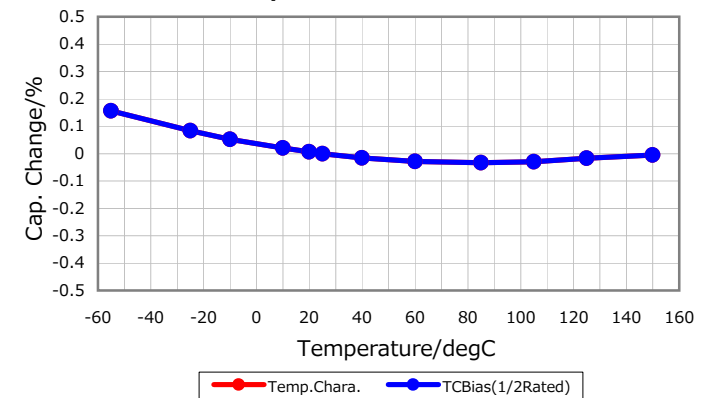

Characterization Sheet (Multilayer Ceramic Chip Capacitors)



All specifications are subject to change without notice.

January 3, 2016