



Is Now Part of



ON Semiconductor®

To learn more about ON Semiconductor, please visit our website at
www.onsemi.com

ON Semiconductor and the ON Semiconductor logo are trademarks of Semiconductor Components Industries, LLC dba ON Semiconductor or its subsidiaries in the United States and/or other countries. ON Semiconductor owns the rights to a number of patents, trademarks, copyrights, trade secrets, and other intellectual property. A listing of ON Semiconductor's product/patent coverage may be accessed at www.onsemi.com/site/pdf/Patent-Marking.pdf. ON Semiconductor reserves the right to make changes without further notice to any products herein. ON Semiconductor makes no warranty, representation or guarantee regarding the suitability of its products for any particular purpose, nor does ON Semiconductor assume any liability arising out of the application or use of any product or circuit, and specifically disclaims any and all liability, including without limitation special, consequential or incidental damages. Buyer is responsible for its products and applications using ON Semiconductor products, including compliance with all laws, regulations and safety requirements or standards, regardless of any support or applications information provided by ON Semiconductor. "Typical" parameters which may be provided in ON Semiconductor data sheets and/or specifications can and do vary in different applications and actual performance may vary over time. All operating parameters, including "Typicals" must be validated for each customer application by customer's technical experts. ON Semiconductor does not convey any license under its patent rights nor the rights of others. ON Semiconductor products are not designed, intended, or authorized for use as a critical component in life support systems or any FDA Class 3 medical devices or medical devices with a same or similar classification in a foreign jurisdiction or any devices intended for implantation in the human body. Should Buyer purchase or use ON Semiconductor products for any such unintended or unauthorized application, Buyer shall indemnify and hold ON Semiconductor and its officers, employees, subsidiaries, affiliates, and distributors harmless against all claims, costs, damages, and expenses, and reasonable attorney fees arising out of, directly or indirectly, any claim of personal injury or death associated with such unintended or unauthorized use, even if such claim alleges that ON Semiconductor was negligent regarding the design or manufacture of the part. ON Semiconductor is an Equal Opportunity/Affirmative Action Employer. This literature is subject to all applicable copyright laws and is not for resale in any manner.

FSBB20CH60

Motion SPM® 3 Series

Features

- UL Certified No. E209204 (UL1557)
- 600 V - 20 A 3-Phase IGBT Inverter with Integral Gate Drivers and Protection
- Low-Loss, Short-Circuit Rated IGBTs
- Very Low Thermal Resistance Using Al₂O₃ DBC Substrate
- Dedicated Vs Pins Simplify PCB Layout
- Separate Open-Emitter Pins from Low-Side IGBTs for Three-Phase Current Sensing
- Single-Grounded Power Supply
- Isolation Rating: 2500 V_{rms} / min.

Applications

- Motion Control - Home Appliance / Industrial Motor

Related Resources

- [AN-9035 - Motion SPM 3 Series Ver.2 User's Guide](#)

General Description

FSBB20CH60 is a Motion SPM® 3 module providing a fully-featured, high-performance inverter output stage for AC Induction, BLDC, and PMSM motors. These modules integrate optimized gate drive of the built-in IGBTs to minimize EMI and losses, while also providing multiple on-module protection features including under-voltage lockouts, over-current shutdown, and fault reporting. The built-in, high-speed HVIC requires only a single supply voltage and translates the incoming logic-level gate inputs to the high-voltage, high-current drive signals required to properly drive the module's internal IGBTs. Separate negative IGBT terminals are available for each phase to support the widest variety of control algorithms.

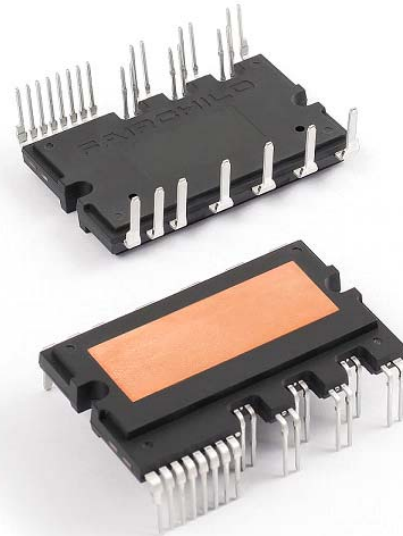

Figure 1. Package Overview

Package Marking and Ordering Information

| Device | Device Marking | Package | Packing Type | Quantity |
|------------|----------------|-----------|--------------|----------|
| FSBB20CH60 | FSBB20CH60 | SPMCA-027 | Rail | 10 |

Integrated Power Functions

- 600 V - 20 A IGBT inverter for three-phase DC / AC power conversion (please refer to Figure 3)

Integrated Drive, Protection and System Control Functions

- For inverter high-side IGBTs: gate drive circuit, high-voltage isolated high-speed level shifting control circuit Under-Voltage Lock-Out Protection (UVLO)
Note: Available bootstrap circuit example is given in Figures 10 and 11.
- For inverter low-side IGBTs: gate drive circuit, Short-Circuit Protection (SCP) control supply circuit Under-Voltage Lock-Out Protection (UVLO)
- Fault signaling: corresponding to UVLO (low-side supply) and SC faults
- Input interface: active-HIGH interface, works with 3.3 / 5 V logic, Schmitt-trigger input

Pin Configuration

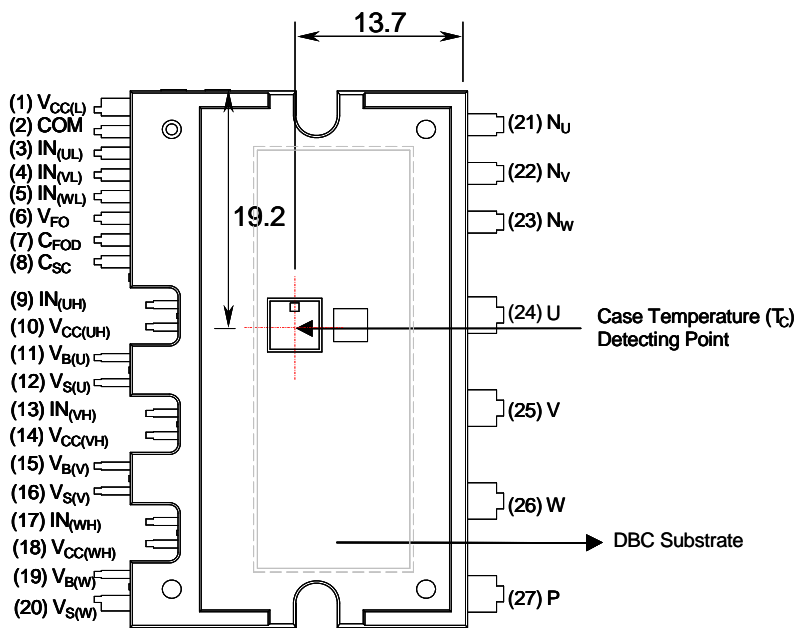

Figure 2. Top View

Pin Descriptions

| Pin Number | Pin Name | Pin Description |
|------------|--------------|---|
| 1 | $V_{CC(L)}$ | Low-Side Common Bias Voltage for IC and IGBTs Driving |
| 2 | COM | Common Supply Ground |
| 3 | $IN_{(UL)}$ | Signal Input for Low-Side U-Phase |
| 4 | $IN_{(VL)}$ | Signal Input for Low-Side V-Phase |
| 5 | $IN_{(WL)}$ | Signal Input for Low-Side W-Phase |
| 6 | V_{FO} | Fault Output |
| 7 | C_{FOD} | Capacitor for Fault Output Duration Selection |
| 8 | C_{SC} | Capacitor (Low-pass Filter) for Short-Circuit Current Detection Input |
| 9 | $IN_{(UH)}$ | Signal Input for High-Side U-Phase |
| 10 | $V_{CC(UH)}$ | High-Side Bias Voltage for U-Phase IC |
| 11 | $V_{B(U)}$ | High-Side Bias Voltage for U-Phase IGBT Driving |
| 12 | $V_{S(U)}$ | High-Side Bias Voltage Ground for U-Phase IGBT Driving |
| 13 | $IN_{(VH)}$ | Signal Input for High-Side V-Phase |
| 14 | $V_{CC(VH)}$ | High-Side Bias Voltage for V-Phase IC |
| 15 | $V_{B(V)}$ | High-Side Bias Voltage for V-Phase IGBT Driving |
| 16 | $V_{S(V)}$ | High-Side Bias Voltage Ground for V-Phase IGBT Driving |
| 17 | $IN_{(WH)}$ | Signal Input for High-Side W Phase |
| 18 | $V_{CC(WH)}$ | High-Side Bias Voltage for W-Phase IC |
| 19 | $V_{B(W)}$ | High-Side Bias Voltage for W-Phase IGBT Driving |
| 20 | $V_{S(W)}$ | High-Side Bias Voltage Ground for W-Phase IGBT Driving |
| 21 | N_U | Negative DC-Link Input for U-Phase |
| 22 | N_V | Negative DC-Link Input for V-Phase |
| 23 | N_W | Negative DC-Link Input for W-Phase |
| 24 | U | Output for U-Phase |
| 25 | V | Output for V-Phase |
| 26 | W | Output for W-Phase |
| 27 | P | Positive DC-Link Input |

Internal Equivalent Circuit and Input/Output Pins



Figure 3. Internal Block Diagram

1st Notes:

1. Inverter low-side is composed of three IGBTs, freewheeling diodes for each IGBT, and one control IC. It has gate drive and protection functions.
2. Inverter power side is composed of four inverter DC-link input terminals and three inverter output terminals.
3. Inverter high-side is composed of three IGBTs, freewheeling diodes, and three drive ICs for each IGBT.

Absolute Maximum Ratings ($T_J = 25^\circ\text{C}$, unless otherwise specified.)

Inverter Part

| Symbol | Parameter | Conditions | Rating | Unit |
|------------------------|------------------------------------|--|-----------|------------------|
| V_{PN} | Supply Voltage | Applied between P- N_U , N_V , N_W | 450 | V |
| $V_{PN(\text{Surge})}$ | Supply Voltage (Surge) | Applied between P- N_U , N_V , N_W | 500 | V |
| V_{CES} | Collector - Emitter Voltage | | 600 | V |
| $\pm I_C$ | Each IGBT Collector Current | $T_C = 25^\circ\text{C}$ | 20 | A |
| $\pm I_{CP}$ | Each IGBT Collector Current (Peak) | $T_C = 25^\circ\text{C}$, Under 1ms Pulse Width | 40 | A |
| P_C | Collector Dissipation | $T_C = 25^\circ\text{C}$ per Chip | 61 | W |
| T_J | Operating Junction Temperature | (2nd Note 1) | -20 ~ 125 | $^\circ\text{C}$ |

2nd Notes:

- The maximum junction temperature rating of the power chips integrated within the Motion SPM® 3 product is 150°C (at $T_C \leq 100^\circ\text{C}$). However, to insure safe operation of the Motion SPM 3 product, the average junction temperature should be limited to $T_{J(\text{ave})} \leq 125^\circ\text{C}$ (at $T_C \leq 100^\circ\text{C}$)

Control Part

| Symbol | Parameter | Conditions | Rating | Unit |
|----------|--------------------------------|---|---------------------|------|
| V_{CC} | Control Supply Voltage | Applied between $V_{CC(UH)}$, $V_{CC(VH)}$, $V_{CC(WH)}$, $V_{CC(L)}$ - COM | 20 | V |
| V_{BS} | High-Side Control Bias Voltage | Applied between $V_{B(U)}$ - $V_{S(U)}$, $V_{B(V)}$ - $V_{S(V)}$, $V_{B(W)}$ - $V_{S(W)}$ | 20 | V |
| V_{IN} | Input Signal Voltage | Applied between $IN_{(UH)}$, $IN_{(VH)}$, $IN_{(WH)}$, $IN_{(UL)}$, $IN_{(VL)}$, $IN_{(WL)}$ - COM | -0.3 ~ 17 | V |
| V_{FO} | Fault Output Supply Voltage | Applied between V_{FO} - COM | -0.3 ~ $V_{CC}+0.3$ | V |
| I_{FO} | Fault Output Current | Sink Current at V_{FO} Pin | 5 | mA |
| V_{SC} | Current-Sensing Input Voltage | Applied between C_{SC} - COM | -0.3 ~ $V_{CC}+0.3$ | V |

Total System

| Symbol | Parameter | Conditions | Rating | Unit |
|-----------------------|--|---|-----------|------------------|
| $V_{PN(\text{PROT})}$ | Self-Protection Supply Voltage Limit (Short-Circuit Protection Capability) | $V_{CC} = V_{BS} = 13.5 \sim 16.5 \text{ V}$ $T_J = 125^\circ\text{C}$, Non-Repetitive, $< 2 \mu\text{s}$ | 400 | V |
| T_C | Module Case Operation Temperature | $-20^\circ\text{C} \leq T_J \leq 125^\circ\text{C}$, See Figure 2 | -20 ~ 100 | $^\circ\text{C}$ |
| T_{STG} | Storage Temperature | | -40 ~ 125 | $^\circ\text{C}$ |
| V_{ISO} | Isolation Voltage | 60 Hz, Sinusoidal, AC 1 Minute, Connect Pins to Heat Sink Plate | 2500 | V_{rms} |

Thermal Resistance

| Symbol | Parameter | Condition | Min. | Typ. | Max. | Unit |
|----------------|-------------------------------------|---------------------------------------|------|------|------|--------------------|
| $R_{th(j-c)Q}$ | Junction to Case Thermal Resistance | Inverter IGBT Part (per 1 / 6 module) | - | - | 1.63 | $^\circ\text{C/W}$ |
| $R_{th(j-c)F}$ | | Inverter FWD Part (per 1 / 6 module) | - | - | 2.55 | $^\circ\text{C/W}$ |

2nd Notes:

- For the measurement point of case temperature(T_C), please refer to Figure 2.

Electrical Characteristics ($T_J = 25^\circ\text{C}$, unless otherwise specified.)

Inverter Part

| Symbol | Parameter | Conditions | Min. | Typ. | Max. | Unit | |
|---------------|--|---|--------------|------|------|---------------|---------------|
| $V_{CE(SAT)}$ | Collector - Emitter Saturation Voltage | $V_{CC} = V_{BS} = 15\text{ V}$ $V_{IN} = 5\text{ V}$ | - | - | 2.3 | V | |
| V_F | FWDI Forward Voltage | $V_{IN} = 0\text{ V}$ | - | - | 2.1 | V | |
| HS | Switching Times | $V_{PN} = 300\text{ V}$, $V_{CC} = V_{BS} = 15\text{ V}$ $I_C = 20\text{ A}$ $V_{IN} = 0\text{ V} \leftrightarrow 5\text{ V}$, Inductive Load (2nd Note 3) | t_{ON} | - | 0.48 | - | μS |
| | | | $t_{C(ON)}$ | - | 0.30 | - | μS |
| | | | t_{OFF} | - | 0.93 | - | μS |
| | | | $t_{C(OFF)}$ | - | 0.52 | - | μS |
| | | | t_{rr} | - | 0.10 | - | μS |
| LS | Switching Times | $V_{PN} = 300\text{ V}$, $V_{CC} = V_{BS} = 15\text{ V}$ $I_C = 20\text{ A}$ $V_{IN} = 0\text{ V} \leftrightarrow 5\text{ V}$, Inductive Load (2nd Note 3) | t_{ON} | - | 0.63 | - | μS |
| | | | $t_{C(ON)}$ | - | 0.30 | - | μS |
| | | | t_{OFF} | - | 1.01 | - | μS |
| | | | $t_{C(OFF)}$ | - | 0.51 | - | μS |
| | | | t_{rr} | - | 0.10 | - | μS |
| I_{CES} | Collector - Emitter Leakage Current | $V_{CE} = V_{CES}$ | - | - | 250 | μA | |

2nd Notes:

3. t_{ON} and t_{OFF} include the propagation delay of the internal drive IC. $t_{C(ON)}$ and $t_{C(OFF)}$ are the switching time of IGBT itself under the given gate driving condition internally. For the detailed information, please see Figure 4.



Figure 4. Switching Time Definition

Electrical Characteristics (T_J = 25°C, unless otherwise specified.)

Control Part

| Symbol | Parameter | Conditions | Min. | Typ. | Max. | Unit | |
|----------------------|--|---|--|------|------|------|----|
| I _{QCCL} | Quiescent V _{CC} Supply Current | V _{CC} = 15 V I _{N(U,L, V,L, W,L)} = 0 V | V _{CC(L)} - COM | - | - | 23 | mA |
| I _{QCCH} | | V _{CC} = 15 V I _{N(U,H, V,H, W,H)} = 0 V | V _{CC(UH)} , V _{CC(VH)} , V _{CC(WH)} - COM | - | - | 100 | μA |
| I _{QBS} | Quiescent V _{BS} Supply Current | V _{BS} = 15 V I _{N(U,H, V,H, W,H)} = 0 V | V _{B(U)} - V _{S(U)} , V _{B(V)} - V _{S(V)} , V _{B(W)} - V _{S(W)} | - | - | 500 | μA |
| V _{FOH} | Fault Output Voltage | V _{SC} = 0 V, V _{FO} Circuit: 4.7 kΩ to 5 V Pull-up | 4.5 | - | - | V | |
| V _{FOL} | | V _{SC} = 1 V, V _{FO} Circuit: 4.7 kΩ to 5 V Pull-up | - | - | 0.8 | V | |
| V _{SC(ref)} | Short Circuit Current Trip Level | V _{CC} = 15 V (2nd Note 4) | 0.45 | 0.50 | 0.55 | V | |
| UV _{CCD} | Supply Circuit Under-Voltage Protection | Detection Level | 10.7 | 11.9 | 13.0 | V | |
| UV _{CCR} | | Reset Level | 11.2 | 12.4 | 13.2 | V | |
| UV _{BSD} | | Detection Level | 10.1 | 11.3 | 12.5 | V | |
| UV _{BSR} | | Reset Level | 10.5 | 11.7 | 12.9 | V | |
| t _{FOD} | Fault-out Pulse Width | C _{FOD} = 33 nF (2nd Note 5) | 1.0 | 1.8 | - | ms | |
| V _{IN(ON)} | ON Threshold Voltage | Applied between I _{N(U,H)} , I _{N(V,H)} , I _{N(W,H)} , I _{N(U,L)} , | 3.0 | - | - | V | |
| V _{IN(OFF)} | OFF Threshold Voltage | I _{N(V,L)} , I _{N(W,L)} - COM | - | - | 0.8 | V | |

2nd Notes:

4. Short-circuit protection is functioning only at the low-sides.

5. The fault-out pulse width t_{FOD} depends on the capacitance value of C_{FOD} according to the following approximate equation: C_{FOD} = 18.3 × 10⁻⁶ × t_{FOD} [F]

Recommended Operating Conditions

| Symbol | Parameter | Conditions | Min. | Typ. | Max. | Unit |
|---|--|--|------|------|------|--------|
| V _{PN} | Supply Voltage | Applied between P - N _U , N _V , N _W | - | 300 | 400 | V |
| V _{CC} | Control Supply Voltage | Applied between V _{CC(UH)} , V _{CC(VH)} , V _{CC(WH)} , V _{CC(L)} - COM | 13.5 | - | 16.5 | V |
| V _{BS} | High-Side Bias Voltage | Applied between V _{B(U)} - V _{S(U)} , V _{B(V)} - V _{S(V)} , V _{B(W)} - V _{S(W)} | 13 | - | 18.5 | V |
| dV _{CC} / dt, dV _{BS} / dt | Control Supply Variation | | -1 | - | 1 | V / μs |
| t _{dead} | Blanking Time for Preventing Arm-Short | For Each Input Signal | 2.5 | - | - | μs |
| f _{PWM} | PWM Input Signal | -20°C ≤ T _C ≤ 100°C, -20°C ≤ T _J ≤ 125°C | - | - | 20 | kHz |
| V _{SEN} | Voltage for Current Sensing | Applied between N _U , N _V , N _W - COM (Including Surge Voltage) | -4 | | 4 | V |

Mechanical Characteristics and Ratings

| Parameter | Conditions | | Min. | Typ. | Max. | Unit |
|-----------------|--------------------|----------------------|------|-------|------|------|
| Mounting Torque | Mounting Screw: M3 | Recommended 0.62 N•m | 0.51 | 0.62 | 0.72 | N•m |
| Device Flatness | | See Figure 5 | 0 | - | +120 | μm |
| Weight | | | - | 15.00 | - | g |



Figure 5. Flatness Measurement Position

Time Charts of Protective Function



- a1 : Control supply voltage rises: after the voltage rises UV_{CCR} , the circuits start to operate when next input is applied.
- a2 : Normal operation: IGBT ON and carrying current.
- a3 : Under-Voltage detection (UV_{CCD}).
- a4 : IGBT OFF in spite of control input condition.
- a5 : Fault output operation starts.
- a6 : Under-Voltage reset (UV_{CCR}).
- a7 : Normal operation: IGBT ON and carrying current.

Figure 6. Under-Voltage Protection (Low-Side)



- b1 : Control supply voltage rises: after the voltage reaches UV_{BSR} , the circuits start to operate when next input is applied.
- b2 : Normal operation: IGBT ON and carrying current.
- b3 : Under-Voltage detection (UV_{BSD}).
- b4 : IGBT OFF in spite of control input condition, but there is no fault output signal.
- b5 : Under-Voltage reset (UV_{BSR}).
- b6 : Normal operation: IGBT ON and carrying current.

Figure 7. Under-Voltage Protection (High-Side)



(with the external shunt resistance and CR connection)

- c1 : Normal operation: IGBT ON and carrying current.
- c2 : Short-Circuit current detection (SC trigger).
- c3 : Hard IGBT gate interrupt.
- c4 : IGBT turns OFF.
- c5 : Fault output timer operation starts: the pulse width of the fault output signal is set by the external capacitor C_{FO} .
- c6 : Input "LOW": IGBT OFF state.
- c7 : Input "HIGH": IGBT ON state, but during the active period of fault output, the IGBT doesn't turn ON.
- c8 : IGBT OFF state.

Figure 8. Short-Circuit Protection (Low-Side Operation Only)



Figure 9. Recommended MCU I/O Interface Circuit

3rd Notes:

1. RC coupling at each input (parts shown dotted) might change depending on the PWM control scheme in the application and the wiring impedance of the application's printed circuit board. The Motion SPM® 3 Product input signal section integrates a 3.3 kΩ(typ.) pull-down resistor. Therefore, when using an external filtering resistor, pay attention to the signal voltage drop at input terminal.
2. The logic input works with standard CMOS or LSTTL outputs.



Figure 10. Recommended Bootstrap Operation Circuit and Parameters

3rd Notes:

3. It would be recommended that the bootstrap diode, D_{BS} , has soft and fast recovery characteristics.
4. The bootstrap resistor (R_{BS}) should be three times greater than $R_{E(H)}$. The recommended value of $R_{E(H)}$ is 5.6 Ω, but it can be increased up to 20 Ω (maximum) for a slower dv/dt of high-side.
5. The ceramic capacitor placed between V_{CC} - COM should be over 1 μF and mounted as close to the pins of the Motion SPM 3 product as possible.

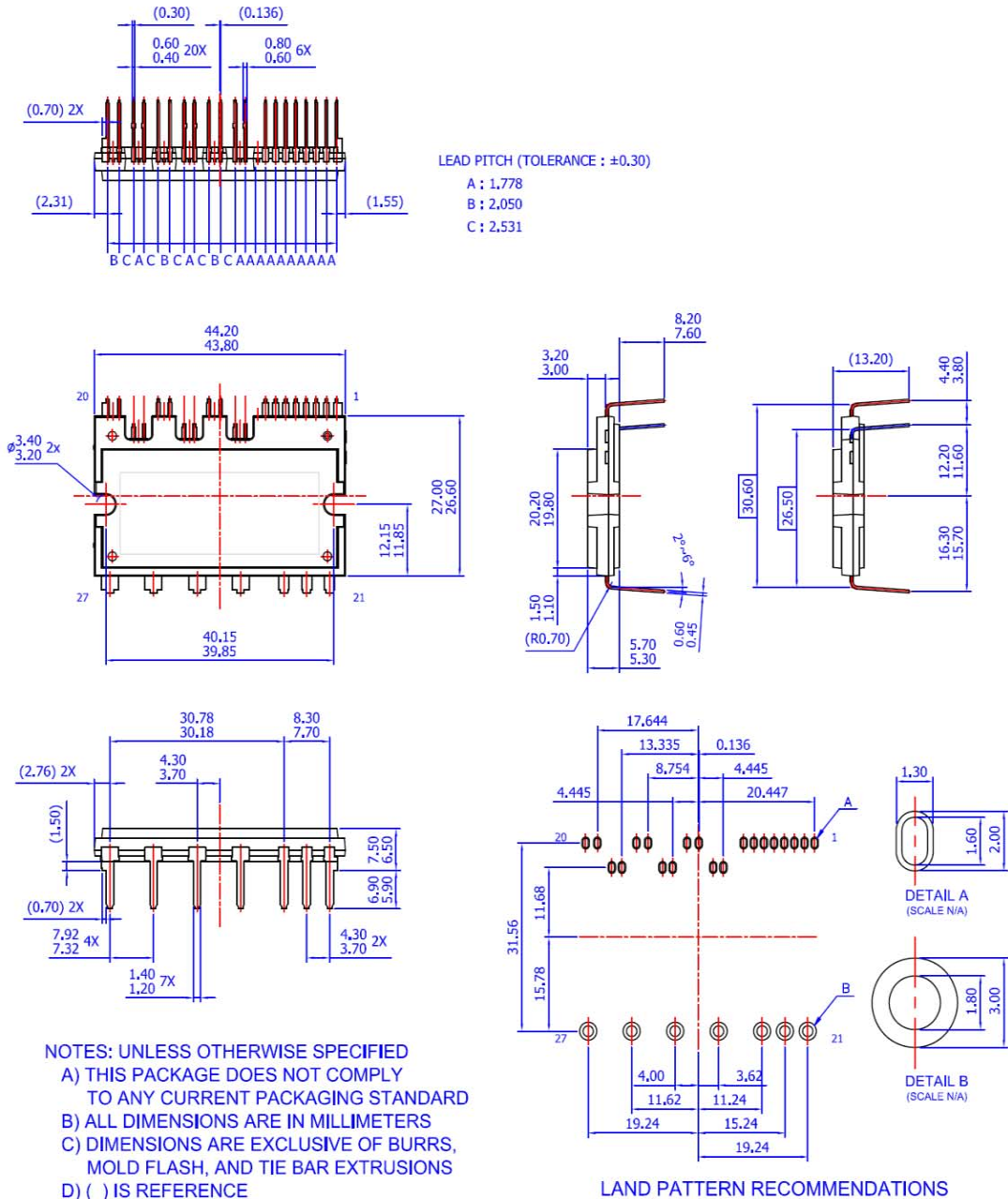

Figure 11. Typical Application Circuit

4th Notes:

1. To avoid malfunction, the wiring of each input should be as short as possible (less than 2 - 3 cm).
2. By virtue of integrating an application-specific type of HVIC inside the Motion SPM® 3 product, direct coupling to MCU terminals without any optocoupler or transformer isolation is possible.
3. V_{FOD} output is open-collector type. This signal line should be pulled up to the positive side of the 5 V power supply with approximately 4.7 kΩ resistance (please refer to Figure 9).
4. C_{SP15} of around seven times larger than bootstrap capacitor C_{BS} is recommended.
5. V_{FOD} output pulse width should be determined by connecting an external capacitor (C_{FOD}) between C_{FOD} (pin 7) and COM (pin 2). (Example : if C_{FOD} = 33 nF, then t_{FOD} = 1.8 ms (typ.)) Please refer to the 2nd note 5 for calculation method.
6. Input signal is active-HIGH type. There is a 3.3 kΩ resistor inside the IC to pull down each input signal line to GND. When employing RC coupling circuits, set up such RC couple that input signal agree with turn-off / turn-on threshold voltage.
7. To prevent errors of the protection function, the wiring around R_f and C_{SC} should be as short as possible.
8. In the short-circuit protection circuit, please select the R_fC_{SC} time constant in the range 1.5 ~ 2 μs.
9. Each capacitor should be mounted as close to the pins of the Motion SPM 3 product as possible.
10. To prevent surge destruction, the wiring between the smoothing capacitor and the P & GND pins should be as short as possible. The use of a high-frequency non-inductive capacitor of around 0.1 ~ 0.22 μF between the P & GND pins is recommended.
11. Relays are used in almost every systems of electrical equipment in home appliances. In these cases, there should be sufficient distance between the MCU and the relays.
12. C_{SP15} should be over 1 μF and mounted as close to the pins of the Motion SPM 3 product as possible.

Detailed Package Outline Drawings



- NOTES: UNLESS OTHERWISE SPECIFIED
- A) THIS PACKAGE DOES NOT COMPLY TO ANY CURRENT PACKAGING STANDARD
 - B) ALL DIMENSIONS ARE IN MILLIMETERS
 - C) DIMENSIONS ARE EXCLUSIVE OF BURRS, MOLD FLASH, AND TIE BAR EXTRUSIONS
 - D) () IS REFERENCE
 - E) [] IS ASS'Y QUALITY
 - F) DRAWING FILENAME: MOD27BAREV2.0
 - G) FAIRCHILD SEMICONDUCTOR





Package drawings are provided as a service to customers considering Fairchild components. Drawings may change in any manner without notice. Please note the revision and/or data on the drawing and contact a FairchildSemiconductor representative to verify or obtain the most recent revision. Package specifications do not expand the terms of Fairchild's worldwide therm and conditions, specifically the the warranty therein, which covers Fairchild products.

Always visit Fairchild Semiconductor's online packaging area for the most recent package drawings:

<http://www.fairchildsemi.com/dwg/MO/MOD27BA.pdf>

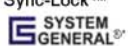
TRADEMARKS

The following includes registered and unregistered trademarks and service marks, owned by Fairchild Semiconductor and/or its global subsidiaries, and is not intended to be an exhaustive list of all such trademarks.

| | | | |
|---|--|---|---|
| AccuPower™ | F-PFS™ |  | Sync-Lock™ |
| AX-CAP®* | FRFET® | PowerTrench® |  SYSTEM GENERAL® |
| BitSiC™ | Global Power Resource™ | PowerXS™ | TinyBoost® |
| Build it Now™ | GreenBridge™ | Programmable Active Droop™ | TinyBuck® |
| CorePLUS™ | Green FPS™ | QFET® | TinyCalc™ |
| CorePOWER™ | Green FPS™ e-Series™ | QS™ | TinyLogic® |
| CROSSVOLT™ | Gmax™ | Quiet Series™ | TINYOPTO™ |
| CTL™ | GTO™ | RapidConfigure™ | TinyPower™ |
| Current Transfer Logic™ | IntelliMAX™ |  | TinyPWM™ |
| DEUXPEED® | ISOPLANAR™ | Saving our world, 1mW/W/kW at a time™ | TinyWire™ |
| Dual Cool™ | Making Small Speakers Sound Louder and Better™ | SignalWise™ | TranSiC™ |
| EcoSPARK® | MegaBuck™ | SmartMax™ | TriFault Detect™ |
| EfficientMax™ | MICROCOUPLER™ | SMART START™ | TRUECURRENT®* |
| ESBC™ | MicroFET™ | Solutions for Your Success™ | µSerDes™ |
|  | MicroPak™ | SPM® |  SerDes® |
| Fairchild® | MicroPak2™ | STEALTH™ | UHC® |
| Fairchild Semiconductor® | MillerDrive™ | SuperFET® | Ultra FRFET™ |
| FACT Quiet Series™ | MotionMax™ | SuperSOT™-3 | UniFET™ |
| FACT® | mWSaver® | SuperSOT™-6 | VCX™ |
| FAST® | OptoHiT™ | SuperSOT™-8 | VisualMax™ |
| FastvCore™ | OPTOLOGIC® | SupreMOS® | VoltagePlus™ |
| FETBench™ | OPTOPLANAR® | SyncFET™ | XS™ |
| FPS™ | | | |

* Trademarks of System General Corporation, used under license by Fairchild Semiconductor.

DISCLAIMER

FAIRCHILD SEMICONDUCTOR RESERVES THE RIGHT TO MAKE CHANGES WITHOUT FURTHER NOTICE TO ANY PRODUCTS HEREIN TO IMPROVE RELIABILITY, FUNCTION, OR DESIGN. FAIRCHILD DOES NOT ASSUME ANY LIABILITY ARISING OUT OF THE APPLICATION OR USE OF ANY PRODUCT OR CIRCUIT DESCRIBED HEREIN; NEITHER DOES IT CONVEY ANY LICENSE UNDER ITS PATENT RIGHTS, NOR THE RIGHTS OF OTHERS. THESE SPECIFICATIONS DO NOT EXPAND THE TERMS OF FAIRCHILD'S WORLDWIDE TERMS AND CONDITIONS, SPECIFICALLY THE WARRANTY THEREIN, WHICH COVERS THESE PRODUCTS.

LIFE SUPPORT POLICY

FAIRCHILD'S PRODUCTS ARE NOT AUTHORIZED FOR USE AS CRITICAL COMPONENTS IN LIFE SUPPORT DEVICES OR SYSTEMS WITHOUT THE EXPRESS WRITTEN APPROVAL OF FAIRCHILD SEMICONDUCTOR CORPORATION.

As used herein:

1. Life support devices or systems are devices or systems which, (a) are intended for surgical implant into the body or (b) support or sustain life, and (c) whose failure to perform when properly used in accordance with instructions for use provided in the labeling, can be reasonably expected to result in a significant injury of the user.
2. A critical component in any component of a life support, device, or system whose failure to perform can be reasonably expected to cause the failure of the life support device or system, or to affect its safety or effectiveness.

ANTI-COUNTERFEITING POLICY

Fairchild Semiconductor Corporation's Anti-Counterfeiting Policy. Fairchild's Anti-Counterfeiting Policy is also stated on our external website, www.fairchildsemi.com, under Sales Support.

Counterfeiting of semiconductor parts is a growing problem in the industry. All manufacturers of semiconductor products are experiencing counterfeiting of their parts. Customers who inadvertently purchase counterfeit parts experience many problems such as loss of brand reputation, substandard performance, failed applications, and increased cost of production and manufacturing delays. Fairchild is taking strong measures to protect ourselves and our customers from the proliferation of counterfeit parts. Fairchild strongly encourages customers to purchase Fairchild parts either directly from Fairchild or from Authorized Fairchild Distributors who are listed by country on our web page cited above. Products customers buy either from Fairchild directly or from Authorized Fairchild Distributors are genuine parts, have full traceability, meet Fairchild's quality standards for handling and storage and provide access to Fairchild's full range of up-to-date technical and product information. Fairchild and our Authorized Distributors will stand behind all warranties and will appropriately address any warranty issues that may arise. Fairchild will not provide any warranty coverage or other assistance for parts bought from Unauthorized Sources. Fairchild is committed to combat this global problem and encourage our customers to do their part in stopping this practice by buying direct or from authorized distributors.

PRODUCT STATUS DEFINITIONS

Definition of Terms

| Datasheet Identification | Product Status | Definition |
|--------------------------|-----------------------|---|
| Advance Information | Formative / In Design | Datasheet contains the design specifications for product development. Specifications may change in any manner without notice. |
| Preliminary | First Production | Datasheet contains preliminary data; supplementary data will be published at a later date. Fairchild Semiconductor reserves the right to make changes at any time without notice to improve design. |
| No Identification Needed | Full Production | Datasheet contains final specifications. Fairchild Semiconductor reserves the right to make changes at any time without notice to improve the design. |
| Obsolete | Not In Production | Datasheet contains specifications on a product that is discontinued by Fairchild Semiconductor. The datasheet is for reference information only. |

Rev. 166

ON Semiconductor and  are trademarks of Semiconductor Components Industries, LLC dba ON Semiconductor or its subsidiaries in the United States and/or other countries. ON Semiconductor owns the rights to a number of patents, trademarks, copyrights, trade secrets, and other intellectual property. A listing of ON Semiconductor's product/patent coverage may be accessed at www.onsemi.com/site/pdf/Patent-Marking.pdf. ON Semiconductor reserves the right to make changes without further notice to any products herein. ON Semiconductor makes no warranty, representation or guarantee regarding the suitability of its products for any particular purpose, nor does ON Semiconductor assume any liability arising out of the application or use of any product or circuit, and specifically disclaims any and all liability, including without limitation special, consequential or incidental damages. Buyer is responsible for its products and applications using ON Semiconductor products, including compliance with all laws, regulations and safety requirements or standards, regardless of any support or applications information provided by ON Semiconductor. "Typical" parameters which may be provided in ON Semiconductor data sheets and/or specifications can and do vary in different applications and actual performance may vary over time. All operating parameters, including "Typicals" must be validated for each customer application by customer's technical experts. ON Semiconductor does not convey any license under its patent rights nor the rights of others. ON Semiconductor products are not designed, intended, or authorized for use as a critical component in life support systems or any FDA Class 3 medical devices or medical devices with a same or similar classification in a foreign jurisdiction or any devices intended for implantation in the human body. Should Buyer purchase or use ON Semiconductor products for any such unintended or unauthorized application, Buyer shall indemnify and hold ON Semiconductor and its officers, employees, subsidiaries, affiliates, and distributors harmless against all claims, costs, damages, and expenses, and reasonable attorney fees arising out of, directly or indirectly, any claim of personal injury or death associated with such unintended or unauthorized use, even if such claim alleges that ON Semiconductor was negligent regarding the design or manufacture of the part. ON Semiconductor is an Equal Opportunity/Affirmative Action Employer. This literature is subject to all applicable copyright laws and is not for resale in any manner.

PUBLICATION ORDERING INFORMATION

LITERATURE FULFILLMENT:

Literature Distribution Center for ON Semiconductor
19521 E. 32nd Pkwy, Aurora, Colorado 80011 USA
Phone: 303-675-2175 or 800-344-3860 Toll Free USA/Canada
Fax: 303-675-2176 or 800-344-3867 Toll Free USA/Canada
Email: orderlit@onsemi.com

N. American Technical Support: 800-282-9855 Toll Free
USA/Canada
Europe, Middle East and Africa Technical Support:
Phone: 421 33 790 2910
Japan Customer Focus Center
Phone: 81-3-5817-1050

ON Semiconductor Website: www.onsemi.com
Order Literature: <http://www.onsemi.com/orderlit>
For additional information, please contact your local
Sales Representative