

### POWER MANAGEMENT

#### Features

- Input voltage — 0.7V to 4.5V
- Minimum input startup voltage — 0.865V
- Output voltage — fixed at 3.3V; adjustable from 1.8V to 5.0V
- Peak input current limit — 1.2A
- Output current at 3.3 V<sub>OUT</sub> — 80mA with V<sub>IN</sub> = 1.0V, 190mA with V<sub>IN</sub> = 1.5V
- Efficiency up to 94%
- Internal synchronous rectifier
- Switching frequency — 1.2MHz
- Automatic power save
- Anti-ringing circuit
- Operating supply current (measured at OUT) — 50µA
- Shutdown current — 0.1µA (typ)
- No forward conduction path during shutdown
- Available in ultra-thin 1.5 × 2.0 × 0.6 (mm) MLPD-UT-6 and SOT23-6 packages
- Lead-free and halogen-free
- WEEE and RoHS compliant

#### Applications

- MP3 players
- Smart Phones and cellular phones
- Palmtop computers and handheld Instruments
- PCMCIA cards
- Memory cards
- Digital cordless phones
- Personal medical products
- Wireless VoIP phones
- Small motors

#### Description

The SC120 is a high efficiency, low noise, synchronous step-up DC-DC converter that provides boosted voltage levels in low-voltage handheld applications. The wide input voltage range allows use in systems with single NiMH or alkaline battery cells as well as in systems with higher voltage battery supplies. It features an internal 1.2A switch and synchronous rectifier to achieve up to 94% efficiency and to eliminate the need for an external Schottky diode. The output voltage can be set to 3.3V with internal feedback, or to any voltage within the specified range using a standard resistor divider.

The SC120 operates in Pulse Width Modulation (PWM) mode for moderate to high loads and Power Save Mode (PSAVE) for improved efficiency under light load conditions. It features anti-ringing circuitry for reduced EMI in noise sensitive applications. Output disconnect capability is included to reduce leakage current, improve efficiency, and eliminate external components sometimes needed to disconnect the load from the supply during shutdown.

Low quiescent current is obtained despite a high 1.2MHz operating frequency. Small external components and the space saving MLPD-UT-6, 1.5×2.0×0.6 (mm) package, or low cost SOT23-6 package, make this device an excellent choice for small handheld applications that require the longest possible battery life.

#### Typical Application Circuit

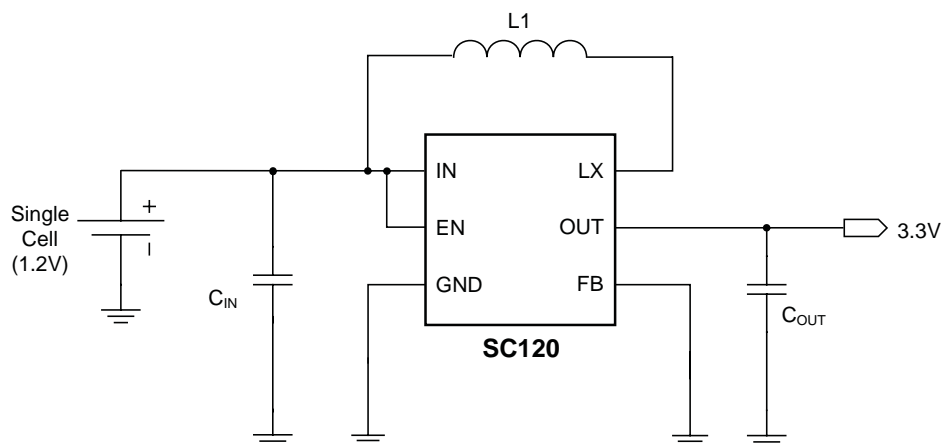

**Pin Configuration — SOT23**

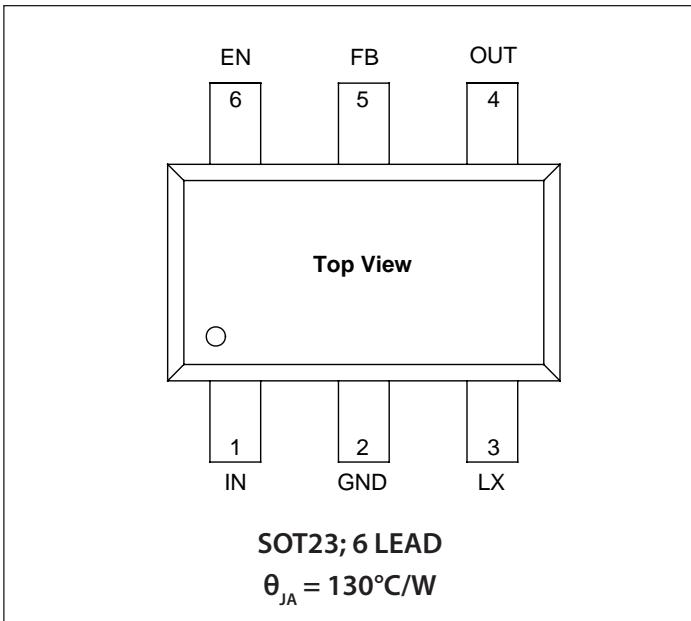

**Marking Information — SOT23**

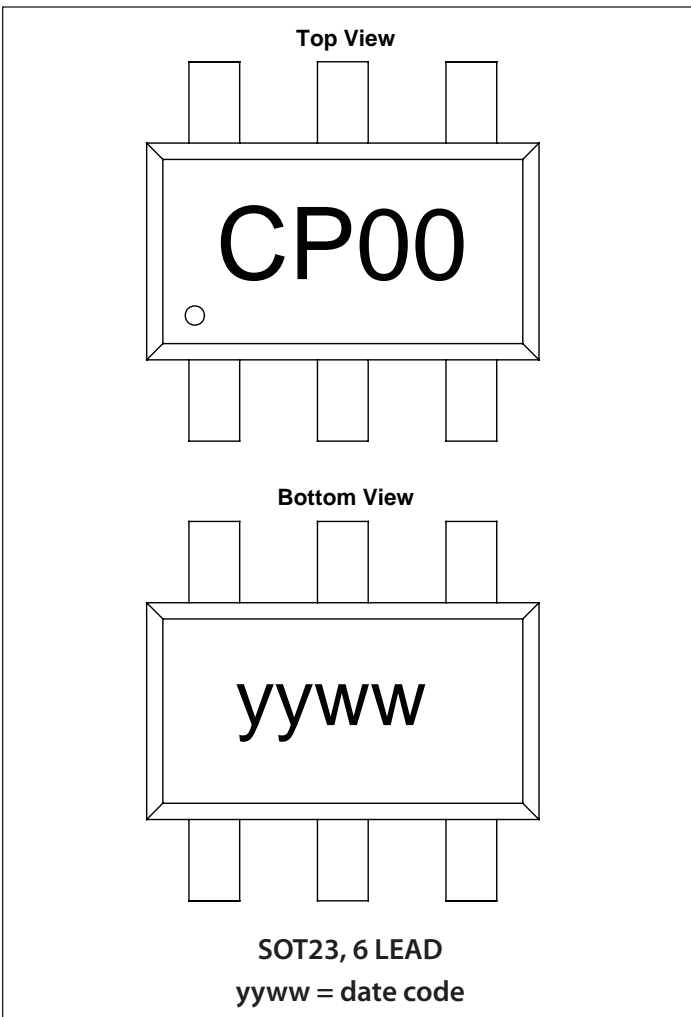

**Ordering Information**

Device	Package
SC120ULTRT <sup>(1)(2)</sup>	MLPD-UT-6 1.5×2
SC120SKTRT <sup>(1)(2)</sup>	SOT23-6
SC120EVB	Evaluation Board, MLPD-UT-6 version
SC120SKEVB	Evaluation Board, SOT23-6 version

Notes:

- (1) Available in tape and reel only. A reel contains 3,000 devices.
- (2) Lead-free packaging, only. Device is WEEE and RoHS compliant, and halogen-free.

**Pin Configuration — MLPD-UT**

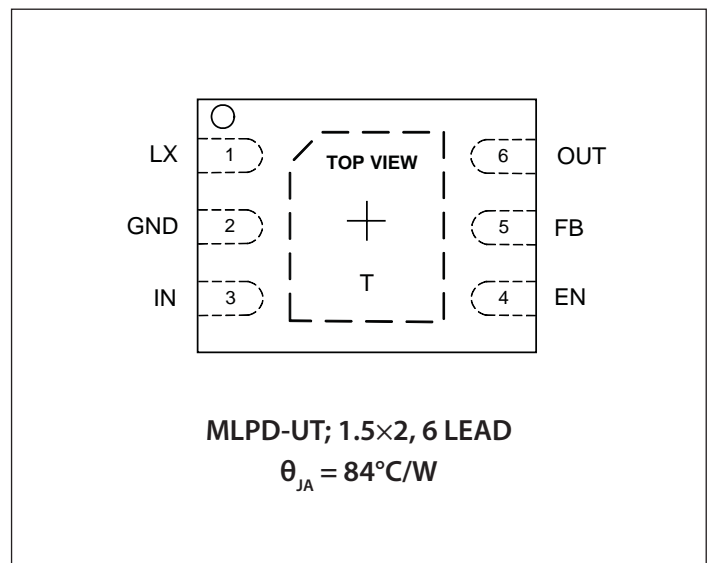

**Marking Information — MLPD-UT**

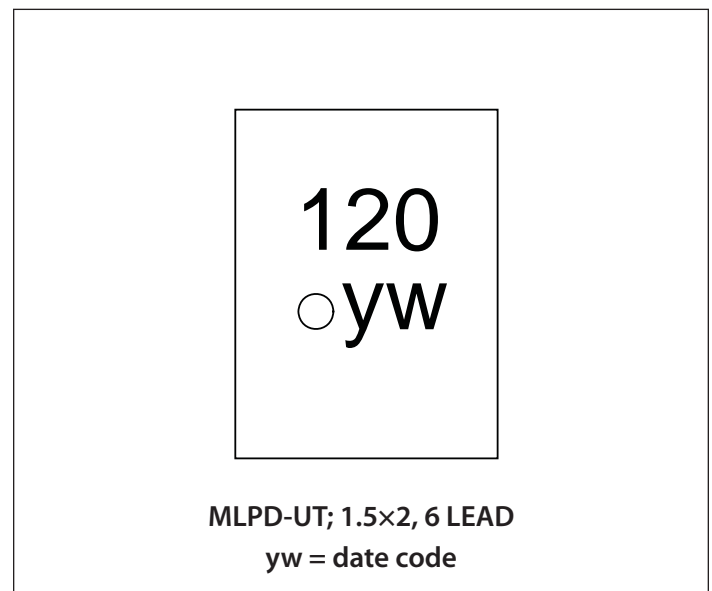

## Absolute Maximum Ratings

IN, OUT, LX, FB (V) .....	-0.3 to +6.0
EN (V) .....	-0.3 to ( $V_{IN} + 0.3$ )
ESD Protection Level <sup>(1)</sup> (kV) .....	3

## Recommended Operating Conditions

Ambient Temperature Range (°C).....	-40 to +85
$V_{IN}$ (V) .....	0.7 to 4.5
$V_{OUT}$ (V).....	1.8 to 5.0

## Thermal Information

Thermal Res. MLPD, Junction-Ambient <sup>(2)</sup> (°C/W) .....	84
Thermal Res., SOT23, Junction -Ambient <sup>(2)</sup> (°C/W) ...	130
Maximum Junction Temperature (°C).....	150
Storage Temperature Range (°C) .....	-65 to +150
Peak IR Reflow Temperature (10s to 30s) (°C) .....	+260

Exceeding the above specifications may result in permanent damage to the device or device malfunction. Operation outside of the parameters specified in the Electrical Characteristics section is not recommended.

### NOTES:

- (1) Tested according to JEDEC standard JESD22-A114.
- (2) Calculated from package in still air, mounted to 3 x 4.5 (in), 4 layer FR4 PCB with thermal vias under the exposed pad per JESD51 standards.

## Electrical Characteristics

Unless otherwise noted  $V_{IN} = 2.5V$ ,  $C_{IN} = C_{OUT} = 22\mu F$ ,  $L_1 = 4.7\mu H$ ,  $T_A = -40$  to  $+85^\circ C$ . Typical values are at  $T_A = 25^\circ C$ .

Parameter	Symbol	Conditions	Min	Typ	Max	Units
Input Voltage Range	$V_{IN}$		0.7		4.5	V
Minimum Startup Voltage	$V_{IN-SU}$	$I_{OUT} < 1mA$ , $T_A = 0^\circ C$ to $85^\circ C$		0.865		V
Shutdown Current	$I_{SHDN}$	$T_A = 25^\circ C$ , $V_{EN} = 0V$		0.1	1	$\mu A$
Operating Supply Current <sup>(1)</sup>	$I_Q$	In PSAVE mode, non-switching, measured at OUT		50		$\mu A$
Internal Oscillator Frequency	$f_{OSC}$			1.2		MHz
Maximum Duty Cycle	$D_{MAX}$			90		%
Minimum Duty Cycle	$D_{MIN}$				15	%
Output Voltage	$V_{OUT}$	$V_{FB} = 0V$		3.3		V
Adjustable Output Voltage Range	$V_{OUT-RNG}$	For $V_{IN}$ such that $D_{MIN} < D < D_{MAX}$	1.8		5.0	V
Regulation Feedback Reference Voltage Accuracy (Internal or External Programming)	$V_{Reg-Ref}$		-1.5		1.5	%
FB Pin Input Current	$I_{FB}$	$V_{FB} = 1.2V$			0.1	$\mu A$
Startup Time	$t_{SU}$			1		ms

## Electrical Characteristics (continued)

Parameter	Symbol	Conditions	Min	Typ	Max	Units
P-Channel ON Resistance	$R_{\text{DSP}}$	$V_{\text{OUT}} = 3.3\text{V}$		0.6		$\Omega$
N-Channel ON Resistance	$R_{\text{DSN}}$	$V_{\text{OUT}} = 3.3\text{V}$		0.5		$\Omega$
N-Channel Current Limit	$I_{\text{LIM(N)}}$	$V_{\text{IN}} = 3.0\text{V}$	0.9	1.2		A
P-Channel Startup Current Limit	$I_{\text{LIM(P)-SU}}$	$V_{\text{IN}} > V_{\text{OUT}}, V_{\text{EN}} > V_{\text{IH}}$		150		mA
LX Leakage Current PMOS	$I_{\text{LXP}}$	$T_{\text{A}} = 25^{\circ}\text{C}, V_{\text{LX}} = 0\text{V}$			1	$\mu\text{A}$
LX Leakage Current NMOS	$I_{\text{LXN}}$	$T_{\text{A}} = 25^{\circ}\text{C}, V_{\text{LX}} = 3.3\text{V}$			1	$\mu\text{A}$
Logic Input High	$V_{\text{IH}}$	$V_{\text{IN}} = 3.0\text{V}$	0.85			V
Logic Input Low	$V_{\text{IL}}$	$V_{\text{IN}} = 3.0\text{V}$			0.2	V
Logic Input Current High	$I_{\text{IH}}$	$V_{\text{EN}} = V_{\text{IN}} = 3.0\text{V}$			1	$\mu\text{A}$
Logic Input Current Low	$I_{\text{IL}}$	$V_{\text{EN}} = 0\text{V}$	-0.2			$\mu\text{A}$

### NOTES:

- (1) Quiescent operating current is drawn from OUT while in regulation. The quiescent operating current projected to IN is approximately  $I_{\text{Q}} \times (V_{\text{OUT}}/V_{\text{IN}})$ .

Typical Characteristics —  $V_{OUT} = 1.8V$

Efficiency vs.  $I_{OUT}$  ( $V_{OUT} = 1.8V$ )

$R_1 = 499k\Omega$ ,  $R_2 = 1M\Omega$ ,  $L = 4.7\mu H$ ,  $T_A = 25^\circ C$

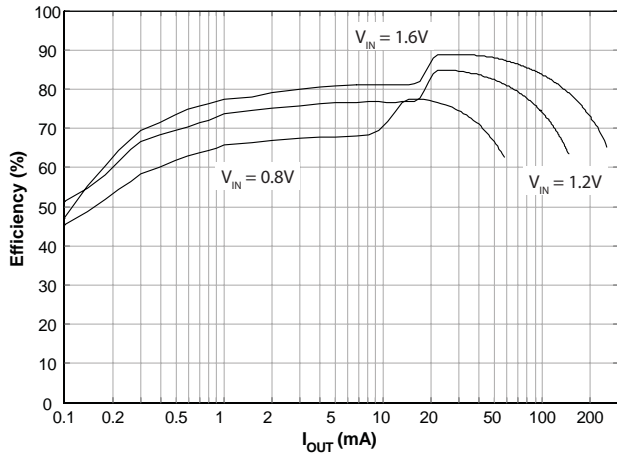

Efficiency vs.  $I_{OUT}$  ( $V_{OUT} = 1.8V$ )

$R_1 = 499k\Omega$ ,  $R_2 = 1M\Omega$ ,  $L = 4.7\mu H$ ,  $V_{IN} = 1.2V$

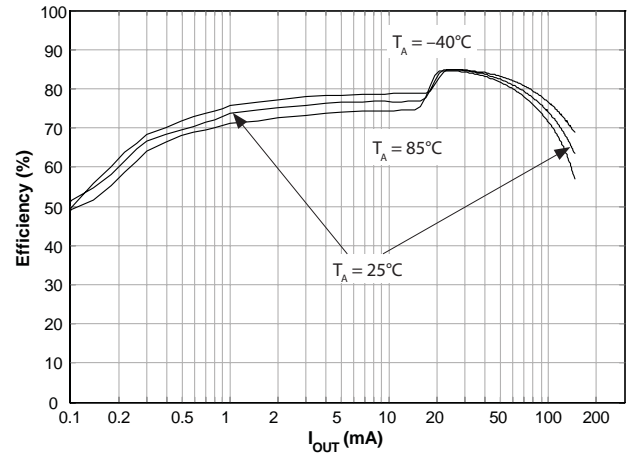

Load Regulation ( $V_{OUT} = 1.8V$ )

$R_1 = 499k\Omega$ ,  $R_2 = 1M\Omega$ ,  $L = 4.7\mu H$ ,  $T_A = 25^\circ C$

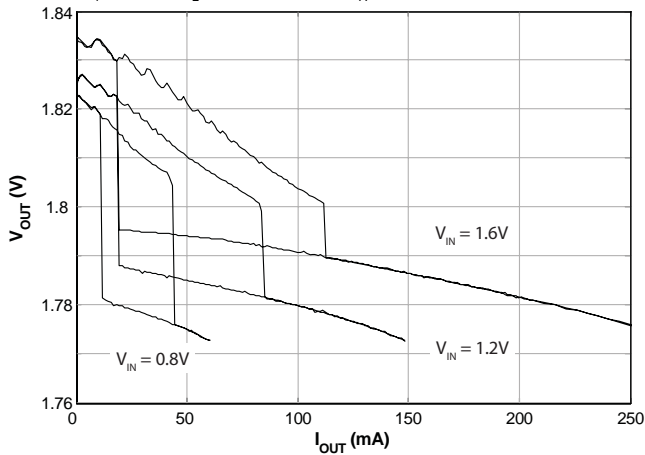

Load Regulation ( $V_{OUT} = 1.8V$ )

$R_1 = 499k\Omega$ ,  $R_2 = 1M\Omega$ ,  $L = 4.7\mu H$ ,  $V_{IN} = 1.2V$

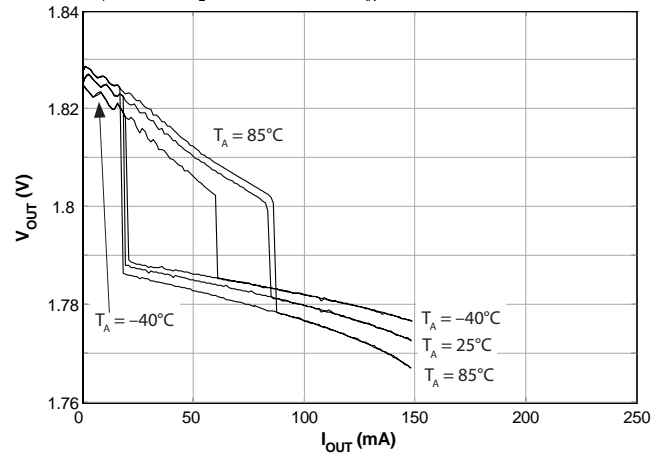

Line Regulation — PSAVE Mode ( $V_{OUT} = 1.8V$ )

$R_1 = 499k\Omega$ ,  $R_2 = 1M\Omega$ ,  $L = 4.7\mu H$ ,  $I_{OUT} = 5mA$

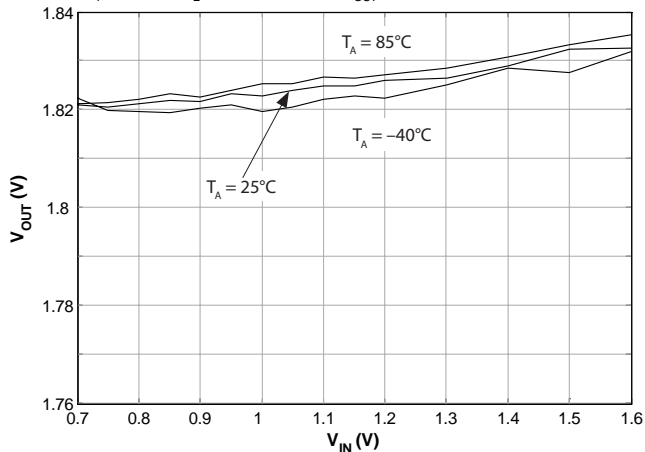

Line Regulation — PWM Mode ( $V_{OUT} = 1.8V$ )

$R_1 = 499k\Omega$ ,  $R_2 = 1M\Omega$ ,  $L = 4.7\mu H$ ,  $I_{OUT} = 35mA$

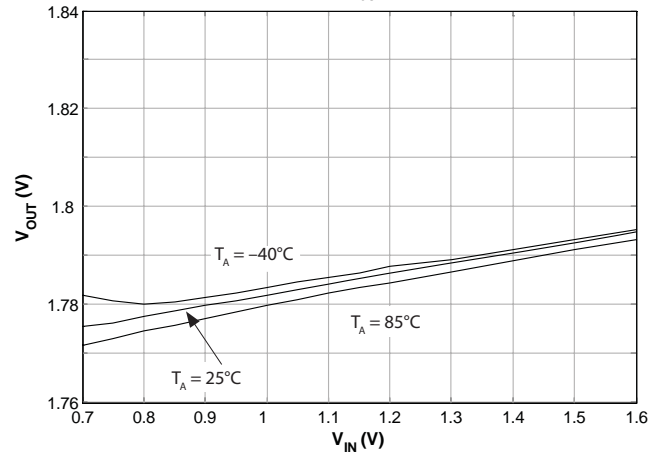

Typical Characteristics —  $V_{OUT} = 1.8V$  (continued)

Temperature Regulation — PSAVE Mode ( $V_{OUT} = 1.8V$ )

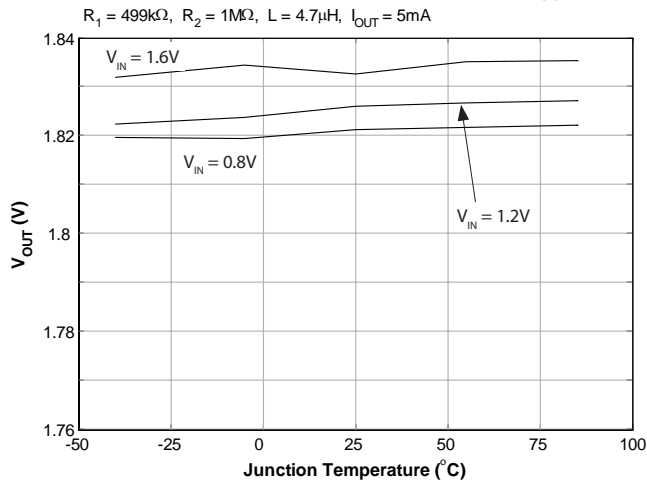

Temperature Regulation — PWM Mode ( $V_{OUT} = 1.8V$ )

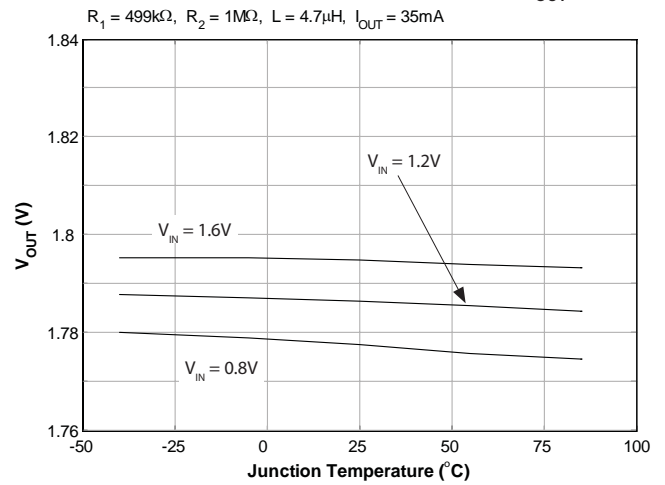

Startup Maximum Load Current vs.  $V_{IN}$  ( $V_{OUT} = 1.8V$ )

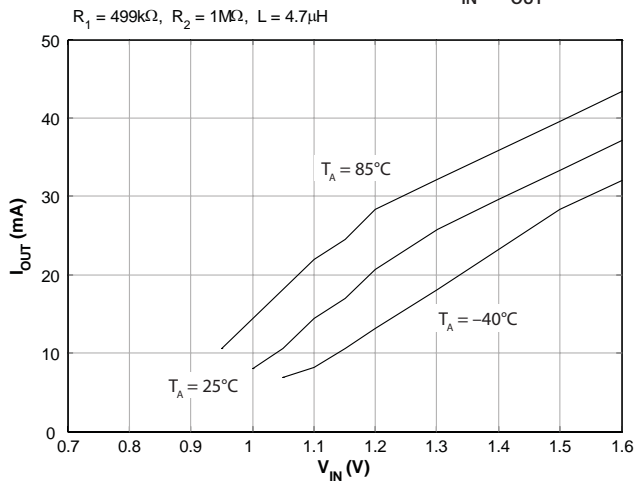

Startup Minimum Load Resistance vs.  $V_{IN}$  ( $V_{OUT} = 1.8V$ )

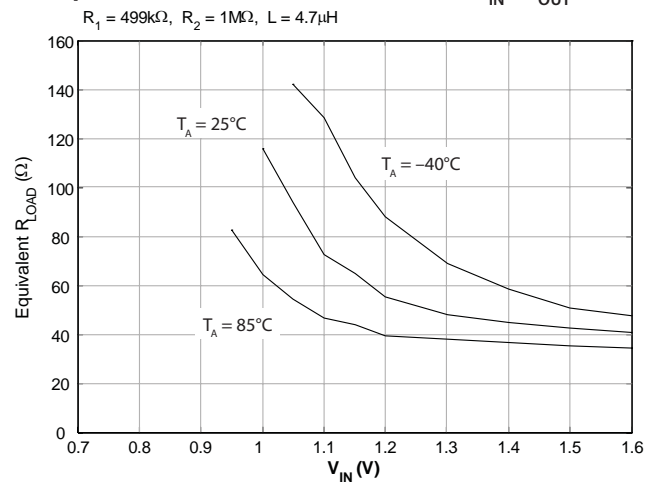

Maximum  $I_{OUT}$  vs.  $V_{IN}$  ( $V_{OUT} = 1.8V$ )

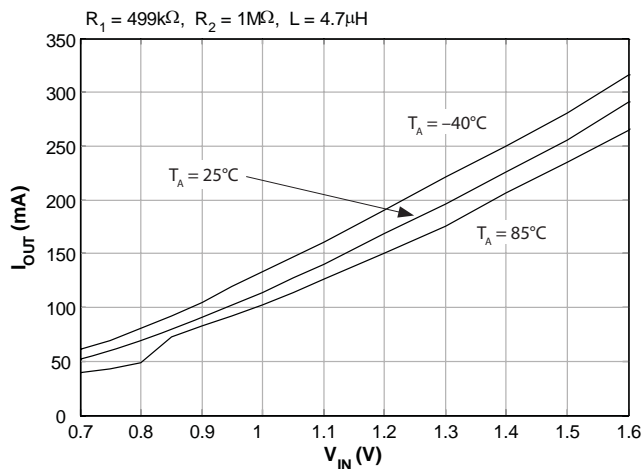

Typical Characteristics —  $V_{OUT} = 3.3V$

Efficiency vs.  $I_{OUT}$  ( $V_{OUT} = 3.3V$ )

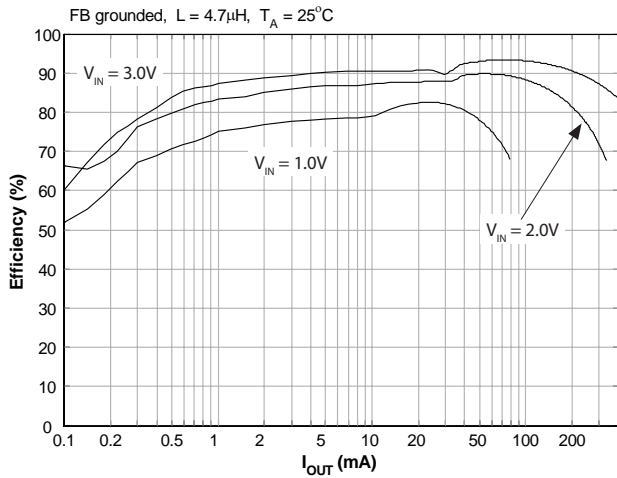

Efficiency vs.  $I_{OUT}$  ( $V_{OUT} = 3.3V$ )

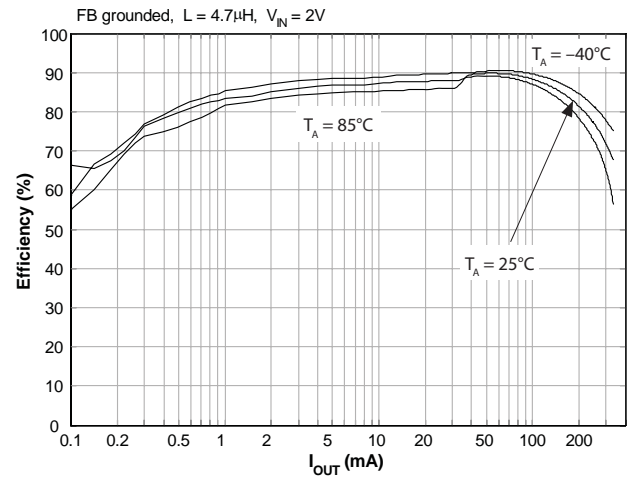

Load Regulation ( $V_{OUT} = 3.3V$ )

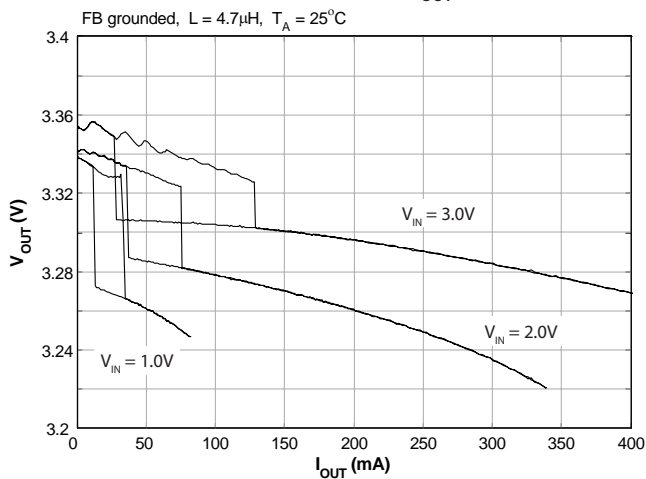

Load Regulation ( $V_{OUT} = 3.3V$ )

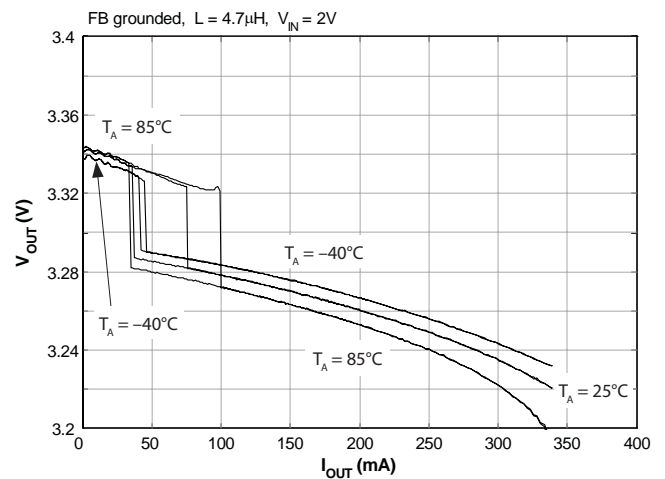

Line Regulation — PSAVE Mode ( $V_{OUT} = 3.3V$ )

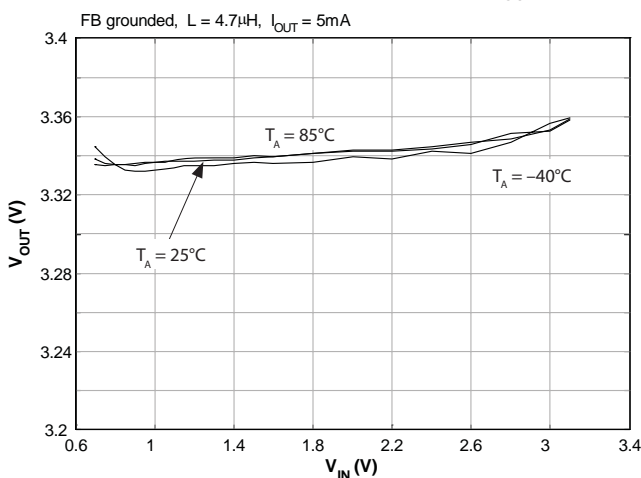

Line Regulation — PWM Mode ( $V_{OUT} = 3.3V$ )

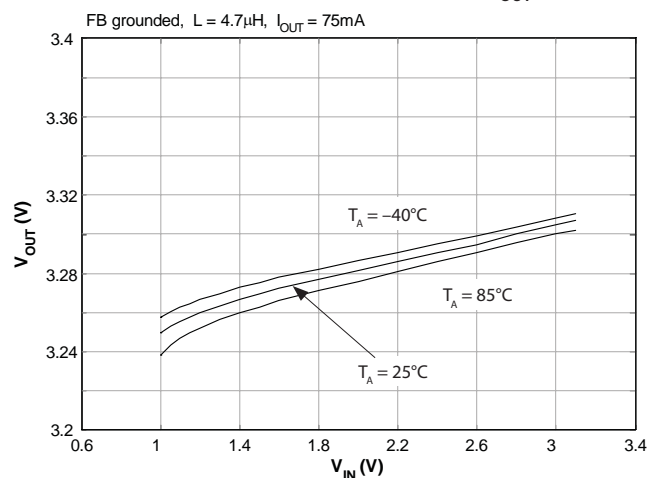

## Typical Characteristics — $V_{OUT} = 3.3V$ (continued)

Temperature Regulation — PSAVE Mode ( $V_{OUT} = 3.3V$ )

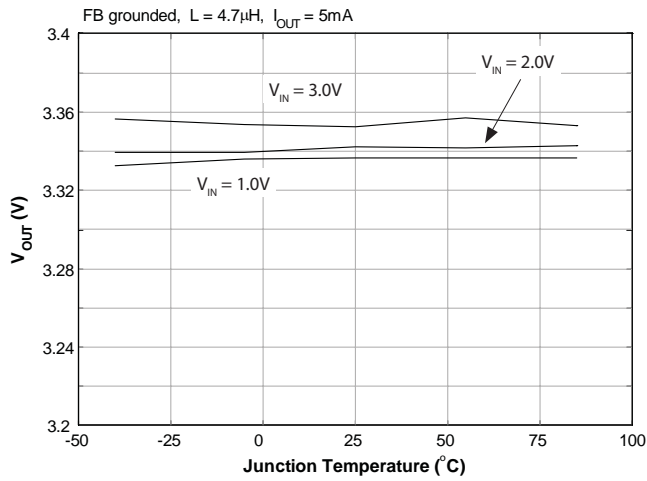

Temperature Regulation — PWM Mode ( $V_{OUT} = 3.3V$ )

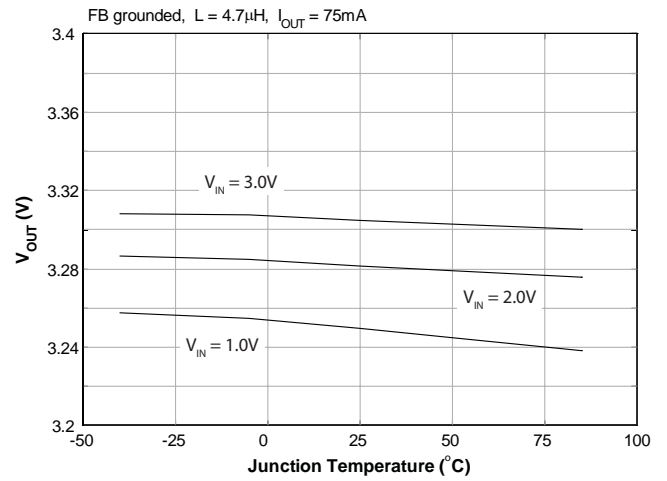

Startup Maximum Load Current vs.  $V_{IN}$  ( $V_{OUT} = 3.3V$ )

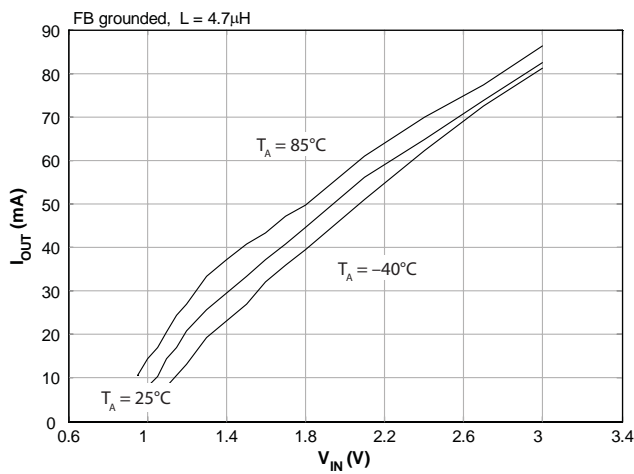

Startup Minimum Load Resistance vs.  $V_{IN}$  ( $V_{OUT} = 3.3V$ )

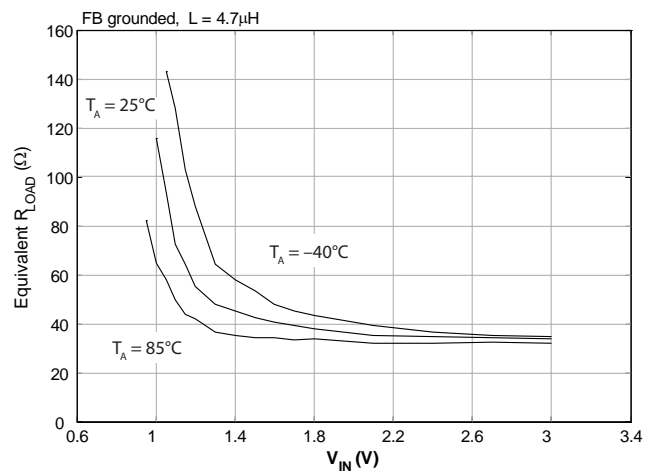

Maximum  $I_{OUT}$  vs.  $V_{IN}$  ( $V_{OUT} = 3.3V$ )

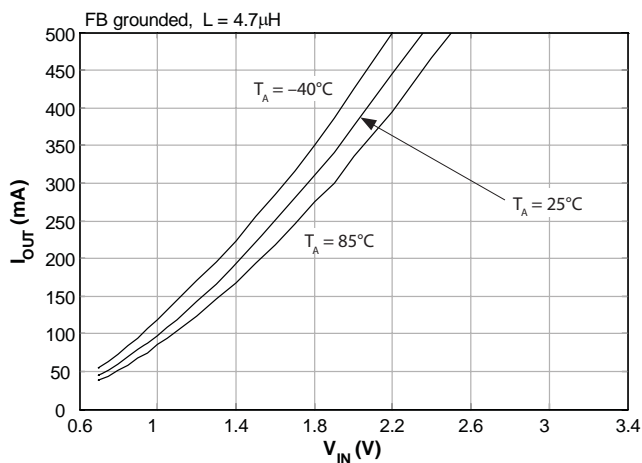



Typical Characteristics —  $V_{OUT} = 4.0V$

Efficiency vs.  $I_{OUT}$  ( $V_{OUT} = 4.0V$ )

$R_1 = 931k\Omega$ ,  $R_2 = 402k\Omega$ ,  $L = 4.7\mu H$ ,  $C_{FB} = 2.2pF$ ,  $T_A = 25^\circ C$

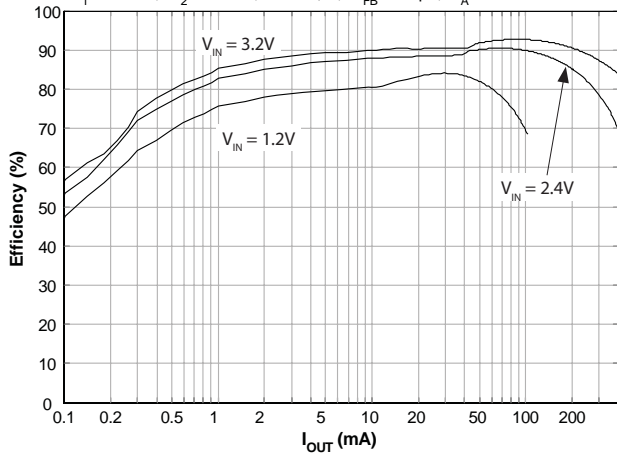

Efficiency vs.  $I_{OUT}$  ( $V_{OUT} = 4.0V$ )

$R_1 = 931k\Omega$ ,  $R_2 = 402k\Omega$ ,  $L = 4.7\mu H$ ,  $C_{FB} = 2.2pF$ ,  $V_{IN} = 2.4V$

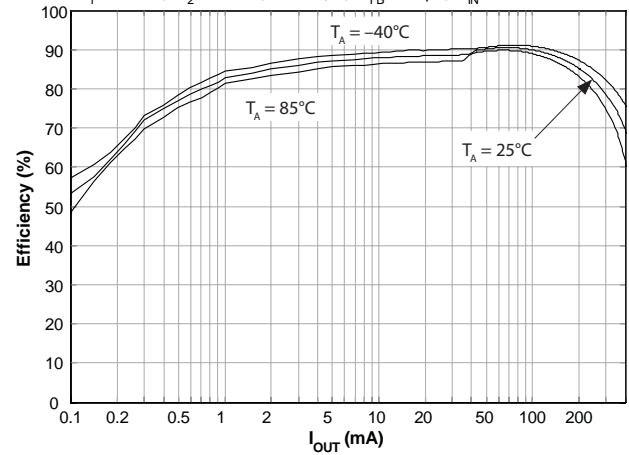

Load Regulation ( $V_{OUT} = 4.0V$ )

$R_1 = 931k\Omega$ ,  $R_2 = 402k\Omega$ ,  $L = 4.7\mu H$ ,  $C_{FB} = 2.2pF$ ,  $T_A = 25^\circ C$

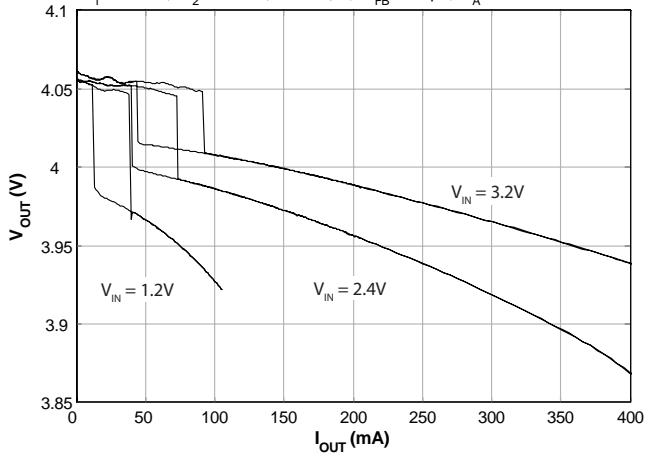

Load Regulation ( $V_{OUT} = 4.0V$ )

$R_1 = 931k\Omega$ ,  $R_2 = 402k\Omega$ ,  $L = 4.7\mu H$ ,  $C_{FB} = 2.2pF$ ,  $V_{IN} = 2.4V$

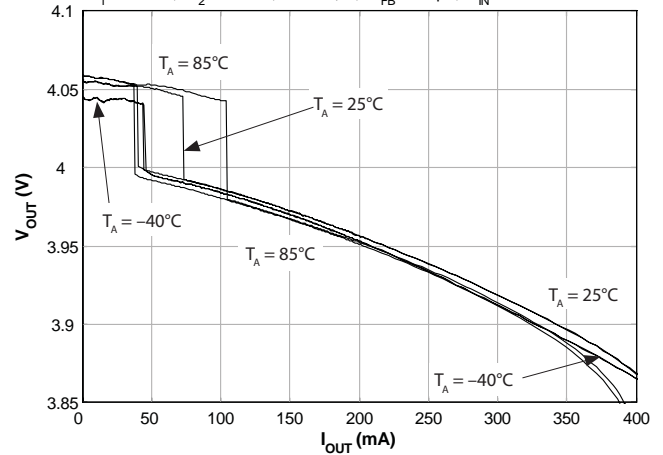

Line Regulation — PSAVE Mode ( $V_{OUT} = 4.0V$ )

$R_1 = 931k\Omega$ ,  $R_2 = 402k\Omega$ ,  $L = 4.7\mu H$ ,  $C_{FB} = 2.2pF$ ,  $I_{OUT} = 5mA$

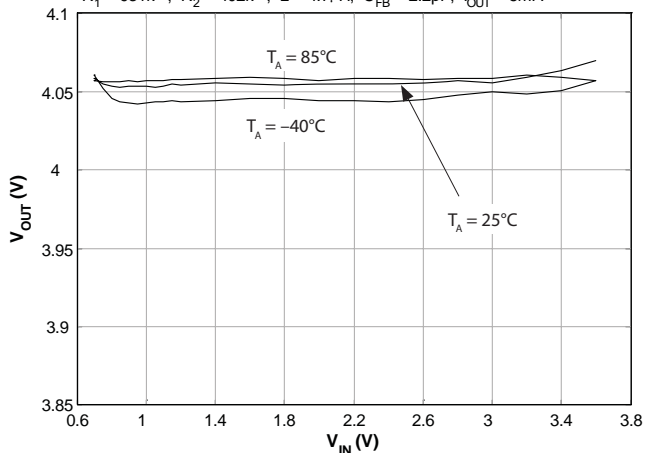

Line Regulation — PWM Mode ( $V_{OUT} = 4.0V$ )

$R_1 = 931k\Omega$ ,  $R_2 = 402k\Omega$ ,  $L = 4.7\mu H$ ,  $C_{FB} = 2.2pF$ ,  $I_{OUT} = 75mA$

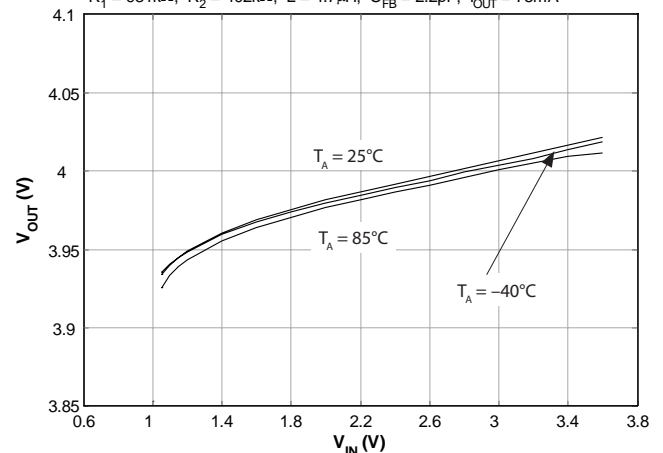

## Typical Characteristics — $V_{OUT} = 4.0V$ (continued)

Temperature Regulation — PSAVE Mode ( $V_{OUT} = 4.0V$ )

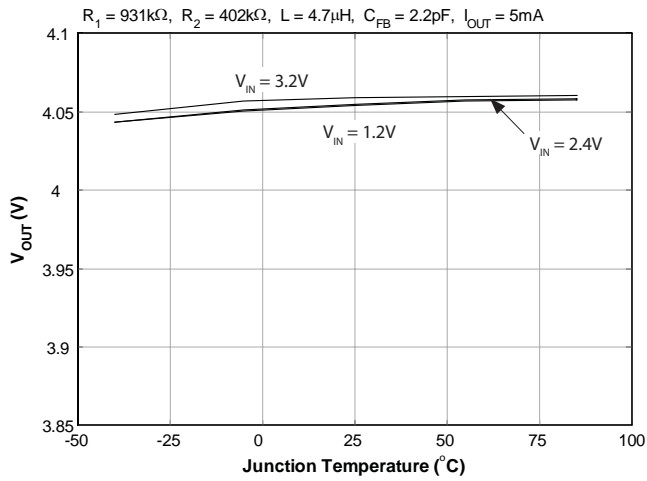

Temperature Regulation — PWM Mode ( $V_{OUT} = 4.0V$ )

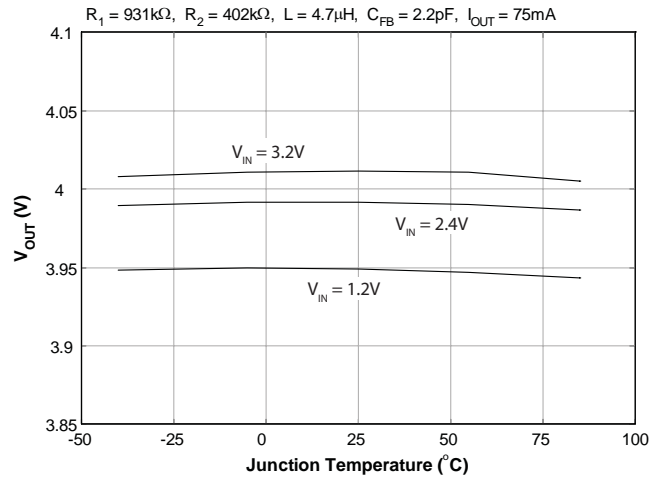

Startup Maximum Load Current vs.  $V_{IN}$  ( $V_{OUT} = 4.0V$ )

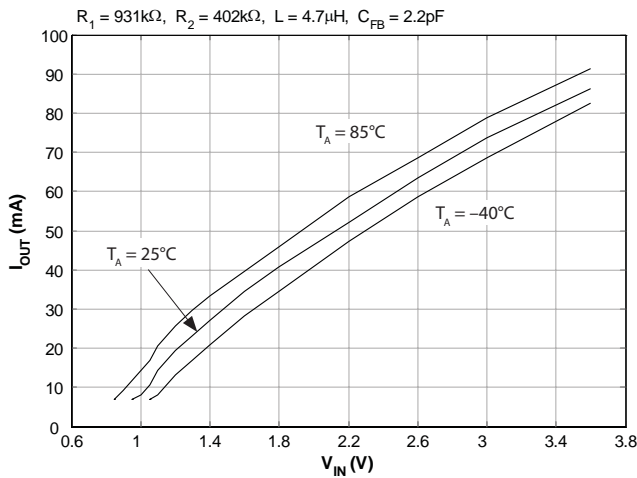

Startup Minimum Load Resistance vs.  $V_{IN}$  ( $V_{OUT} = 4.0V$ )

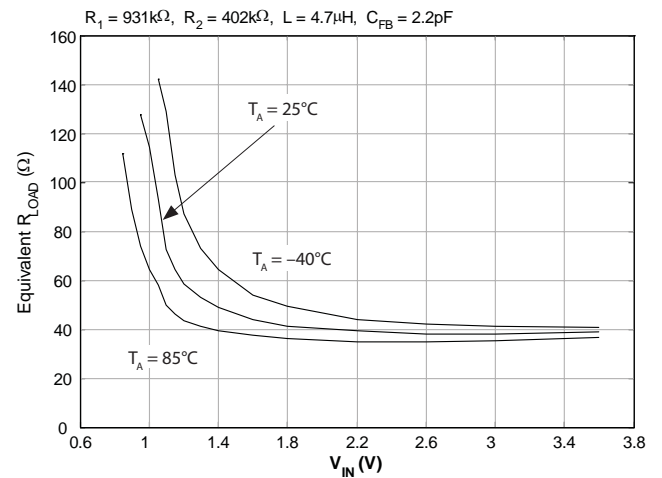

Maximum  $I_{OUT}$  vs.  $V_{IN}$  ( $V_{OUT} = 4.0V$ )

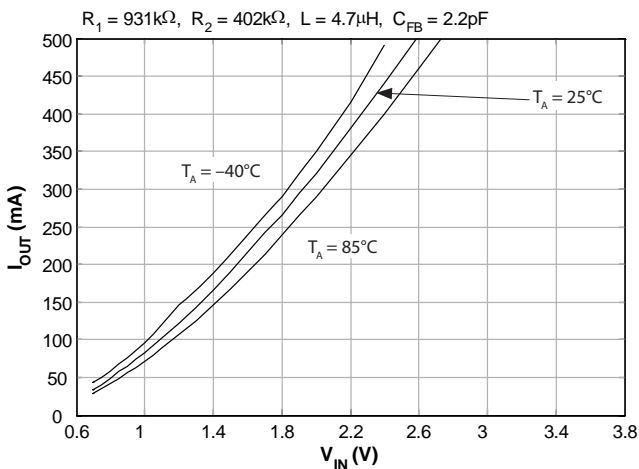

Typical Characteristics —  $V_{OUT} = 5.0V$ , Low  $V_{IN}$  Range

Efficiency vs.  $I_{OUT}$  ( $V_{OUT} = 5.0V$ )

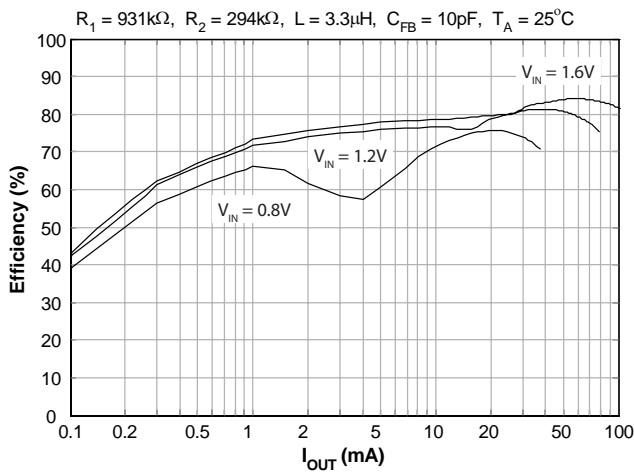

Efficiency vs.  $I_{OUT}$  ( $V_{OUT} = 5.0V$ )

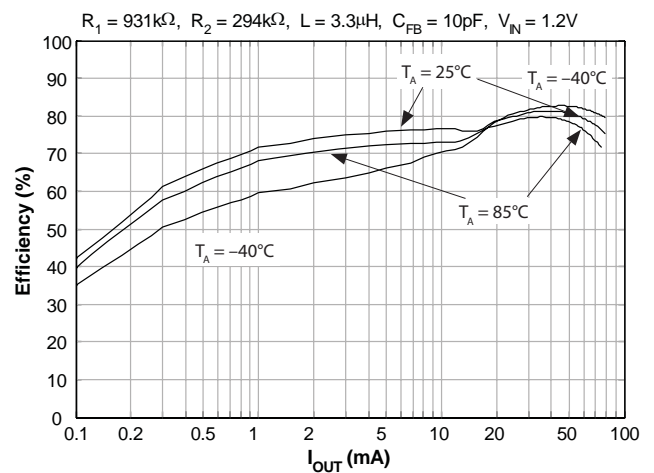

Load Regulation ( $V_{OUT} = 5.0V$ )

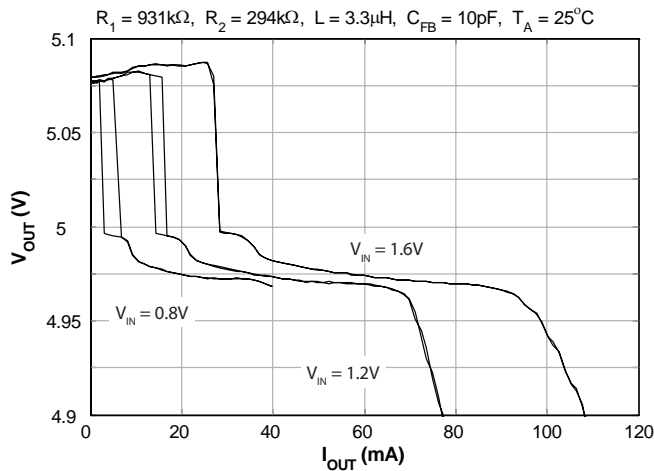

Load Regulation ( $V_{OUT} = 5.0V$ )

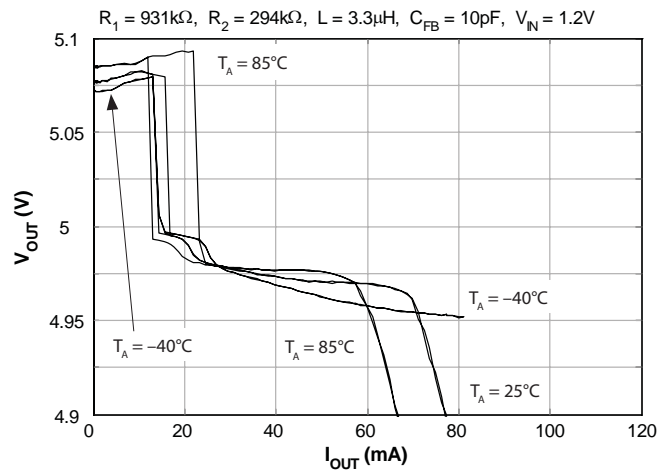

Line Regulation — PSAVE Mode ( $V_{OUT} = 5.0V$ )

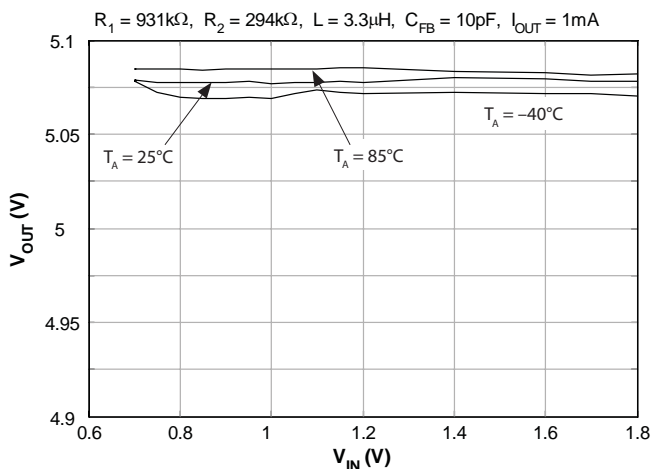

Line Regulation — PWM Mode ( $V_{OUT} = 5.0V$ )

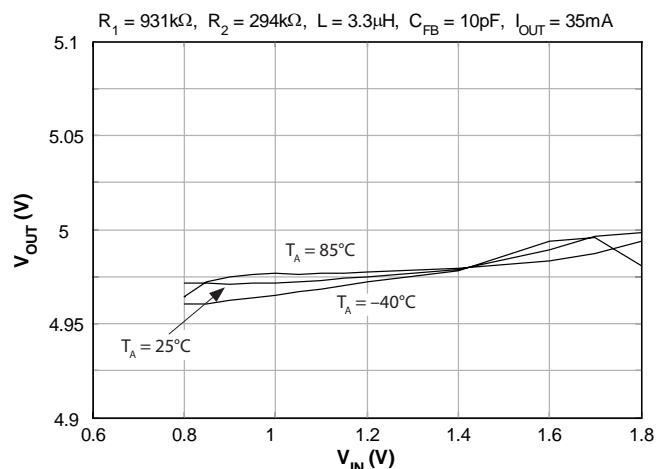

Typical Characteristics —  $V_{OUT} = 5.0V$ , Low  $V_{IN}$  Range (continued)

Temperature Regulation — PSAVE Mode ( $V_{OUT} = 5.0V$ )

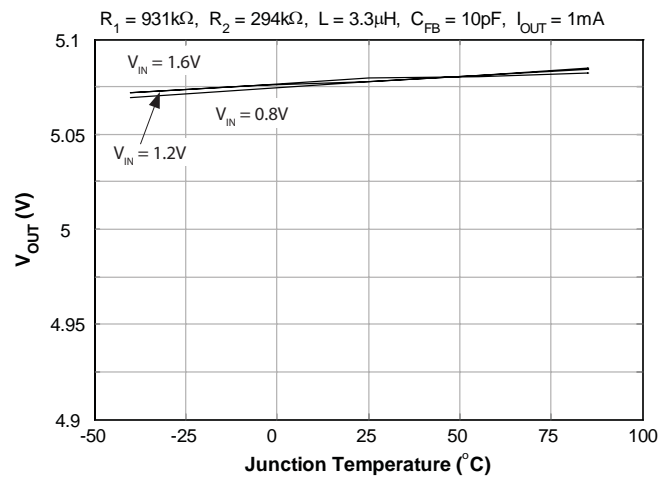

Temperature Regulation — PWM Mode ( $V_{OUT} = 5.0V$ )

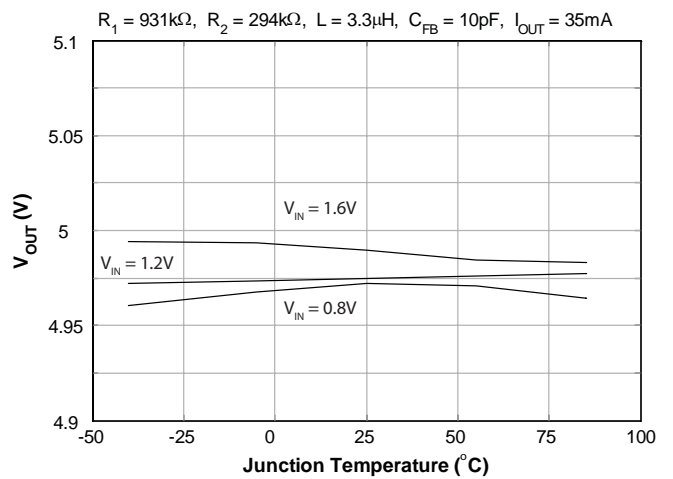

See page 16 for all  $V_{OUT} = 5.0V$  operation and startup load data.

Typical Characteristics —  $V_{OUT} = 5.0V$ , Mid  $V_{IN}$  Range

Efficiency vs.  $I_{OUT}$  ( $V_{OUT} = 5.0V$ )

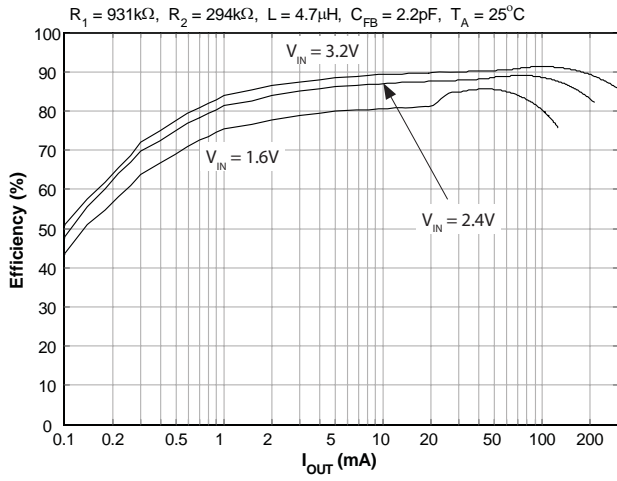

Efficiency vs.  $I_{OUT}$  ( $V_{OUT} = 5.0V$ )

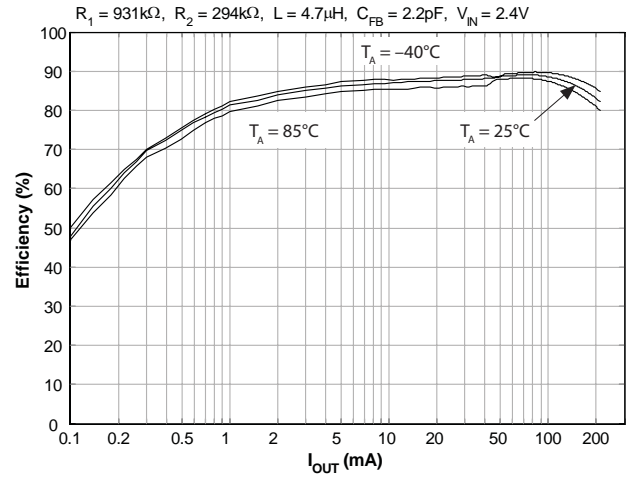

Load Regulation ( $V_{OUT} = 5.0V$ )

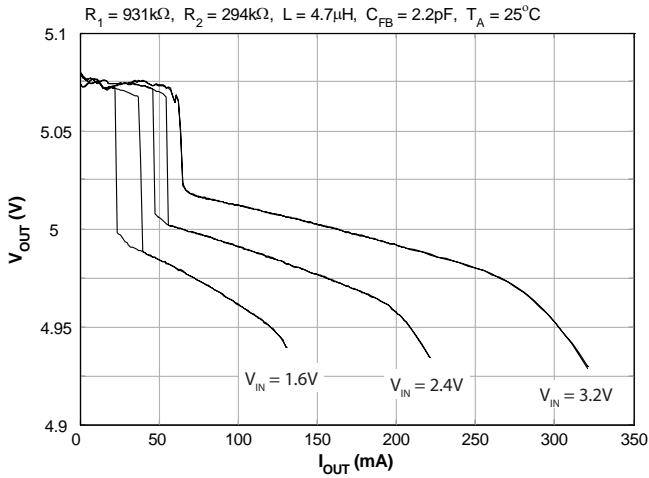

Load Regulation ( $V_{OUT} = 5.0V$ )

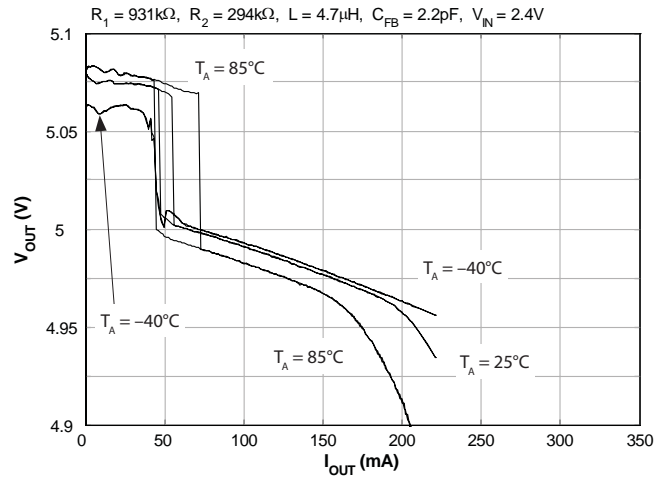

Line Regulation — PSAVE Mode ( $V_{OUT} = 5.0V$ )

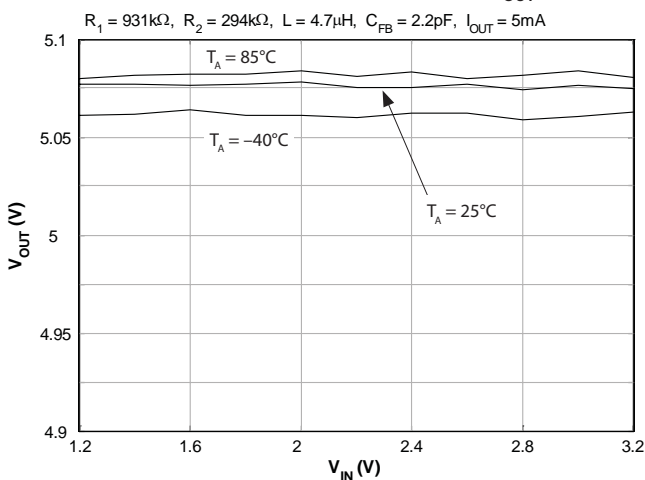

Line Regulation — PWM Mode ( $V_{OUT} = 5.0V$ )

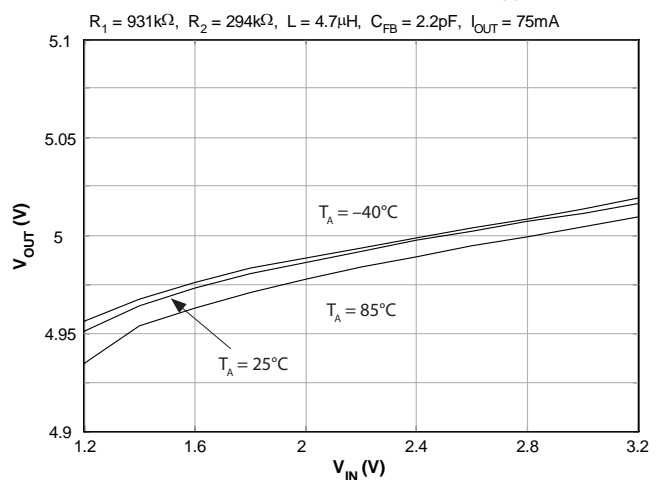

Typical Characteristics —  $V_{OUT} = 5.0V$ , Mid  $V_{IN}$  Range (continued)

Temperature Regulation — PSAVE Mode ( $V_{OUT} = 5.0V$ )

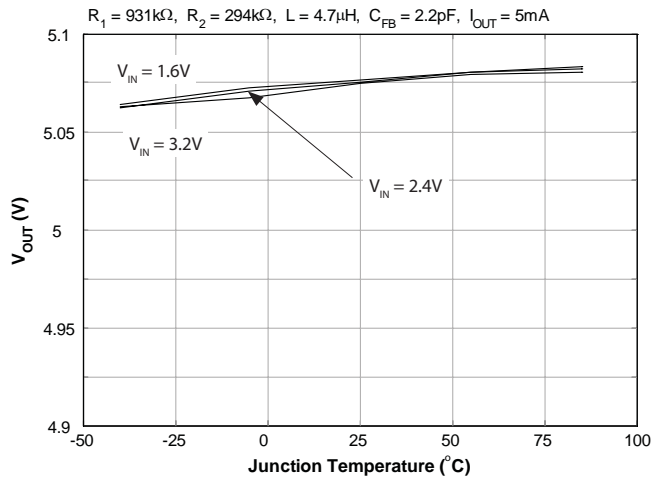

Temperature Regulation — PWM Mode ( $V_{OUT} = 5.0V$ )

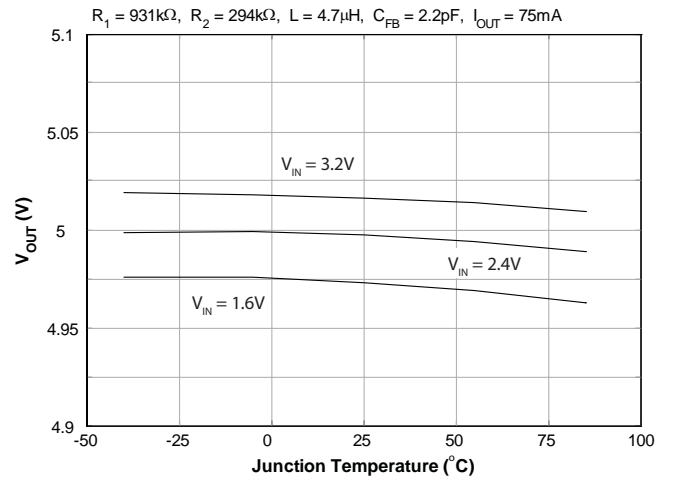

See page 16 for all  $V_{OUT} = 5.0V$  operation and startup load data.

Typical Characteristics —  $V_{OUT} = 5.0V$ , High  $V_{IN}$  Range

Efficiency vs.  $I_{OUT}$  ( $V_{OUT} = 5.0V$ )

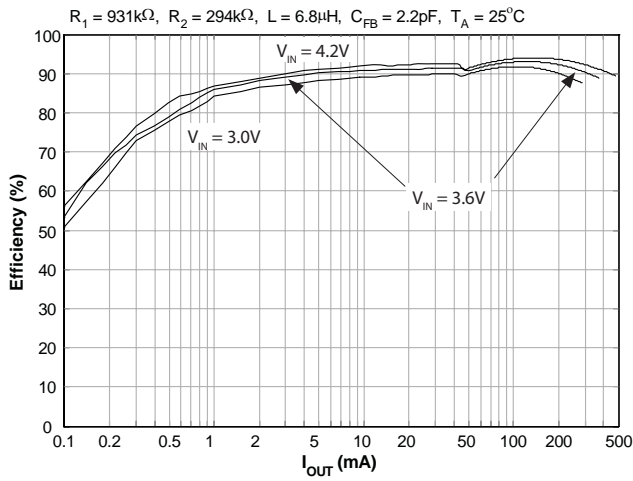

Efficiency vs.  $I_{OUT}$  ( $V_{OUT} = 5.0V$ )

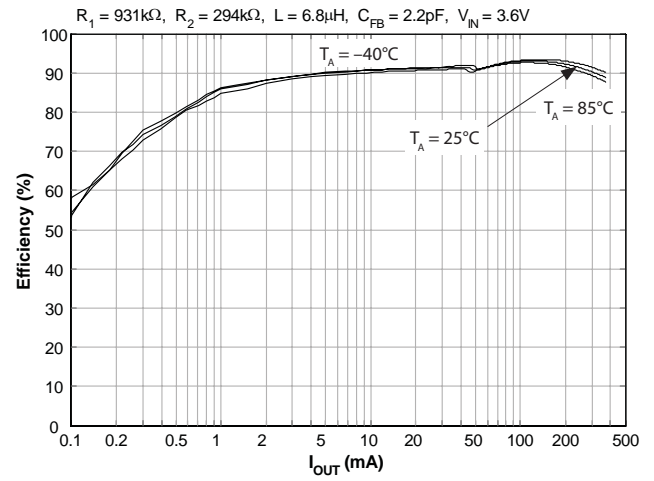

Load Regulation ( $V_{OUT} = 5.0V$ )

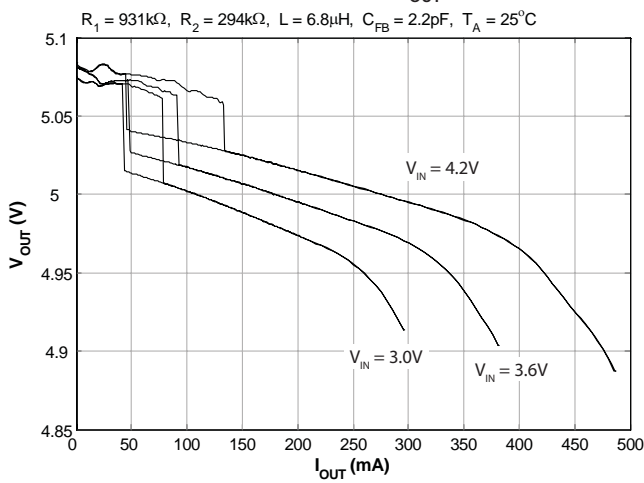

Load Regulation ( $V_{OUT} = 5.0V$ )

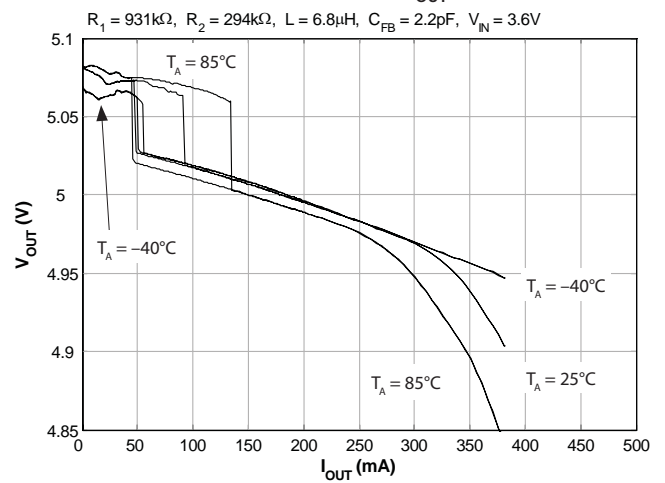

Line Regulation — PSAVE Mode ( $V_{OUT} = 5.0V$ )

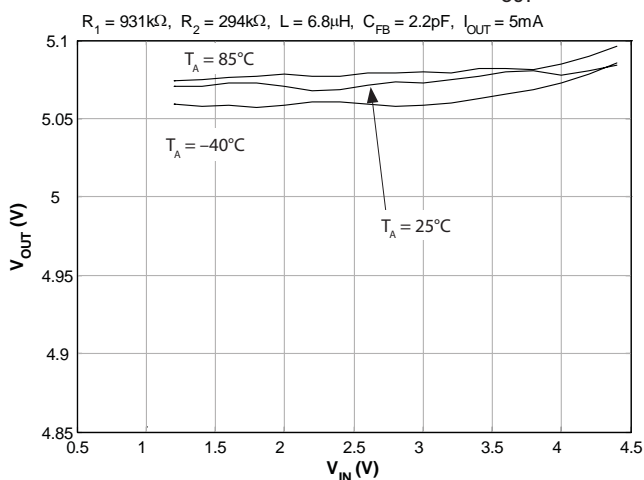

Line Regulation — PWM Mode ( $V_{OUT} = 5.0V$ )

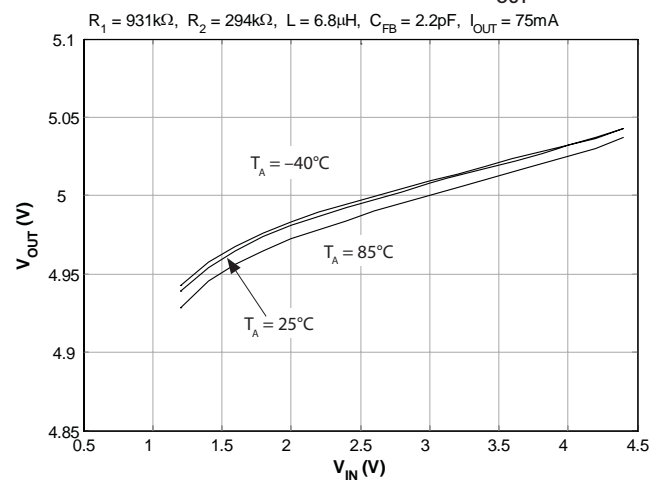

Typical Characteristics —  $V_{OUT} = 5.0V$ , High  $V_{IN}$  Range (continued)

Temperature Regulation — PSAVE Mode ( $V_{OUT} = 5.0V$ )

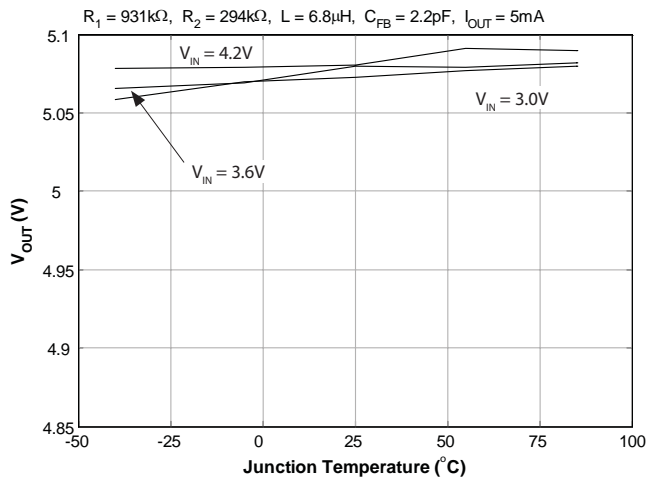

Temperature Regulation — PWM Mode ( $V_{OUT} = 5.0V$ )

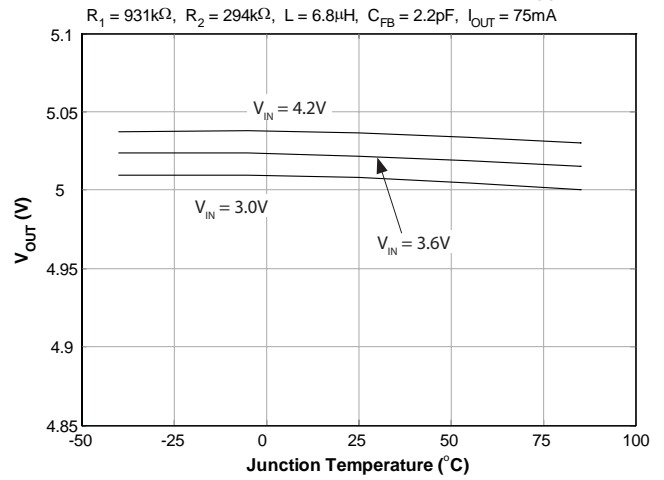

Startup Max. Load Current vs.  $V_{IN}$  ( $V_{OUT} = 5.0V$ , all  $V_{IN}$ 's)

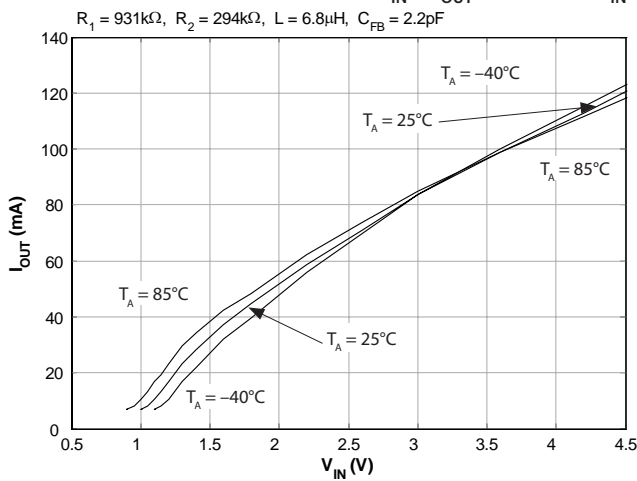

Startup Min. Load Res. vs.  $V_{IN}$  ( $V_{OUT} = 5.0V$ , all  $V_{IN}$  Ranges)

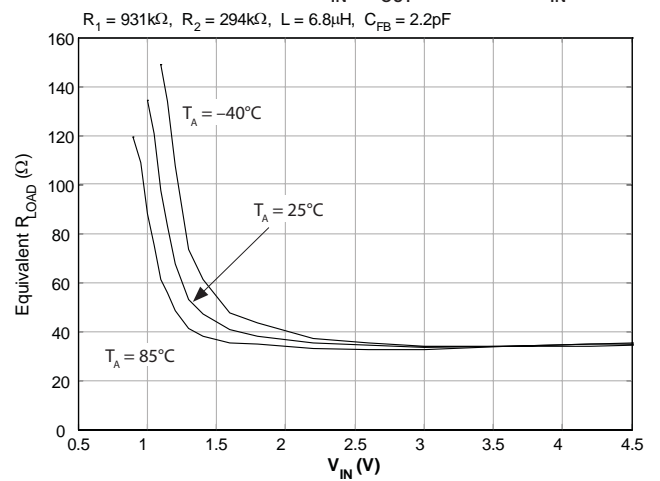

Maximum  $I_{OUT}$  vs.  $V_{IN}$  ( $V_{OUT} = 5.0V$ , all  $V_{IN}$  Ranges)

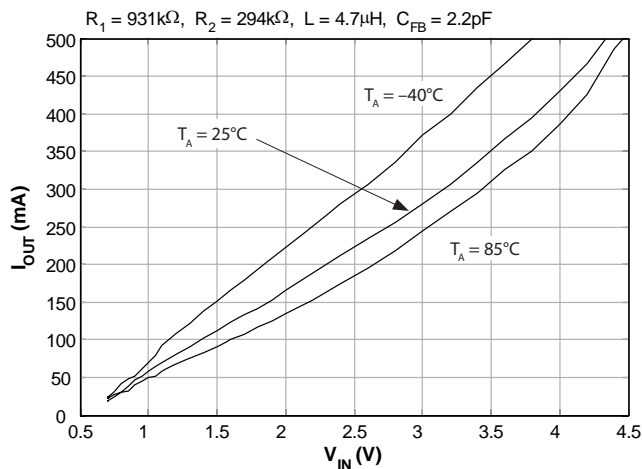



Typical Characteristics (continued)

Load Transient (PSAVE to PWM)

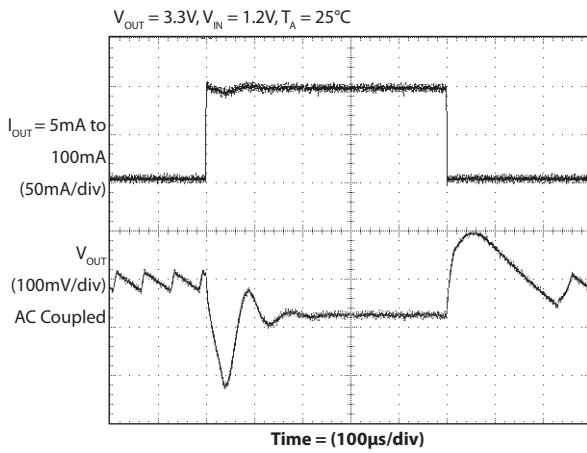

Load Transient (PWM to PWM)

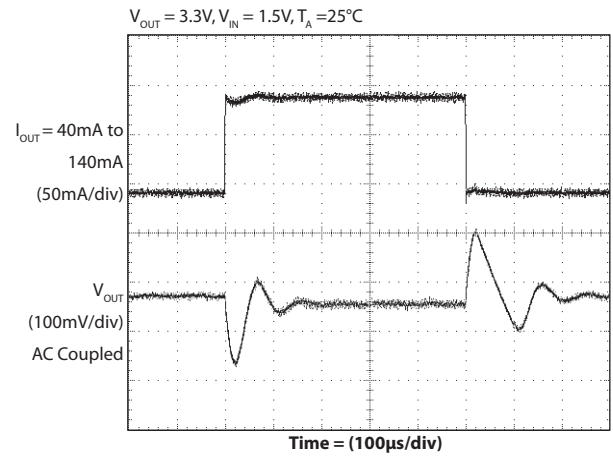

PSAVE Operation

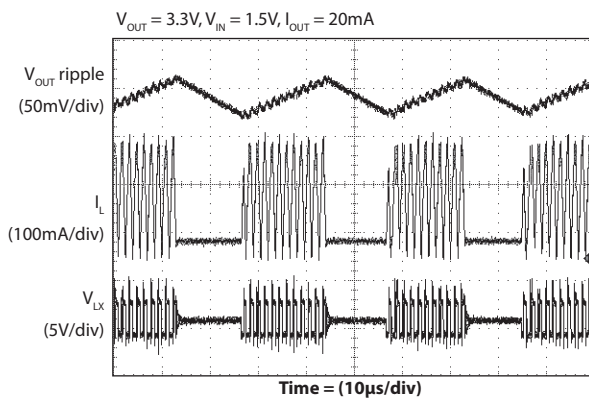

PWM Operation

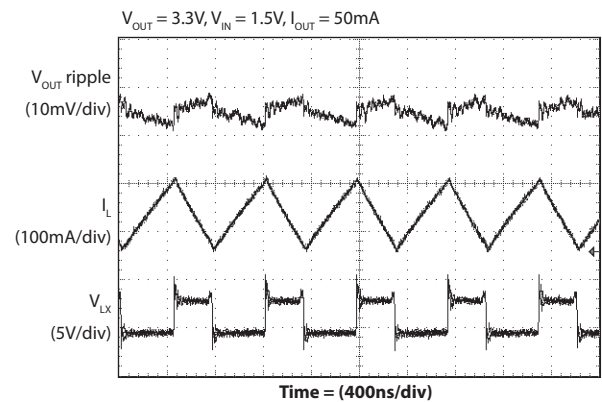

Minimum Startup  $V_{IN}$  vs. Temperature (Any  $V_{OUT}$ )

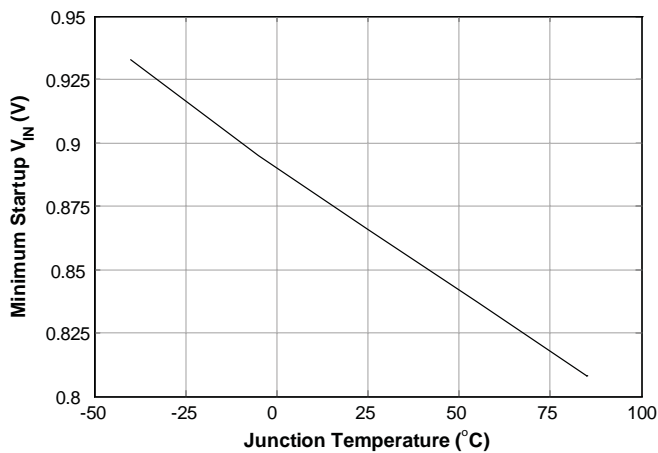

## Pin Descriptions

MLPD Pin #	SOT23 Pin #	Pin Name	Pin Function
1	3	LX	Switching node — connect an inductor from the input supply to this pin.
2	2	GND	Signal and power ground.
3	1	IN	Battery or supply input — requires an external 10 $\mu$ F bypass capacitor (capacitance evaluated while under $V_{IN}$ bias) for normal operation.
4	6	EN	Enable digital control input — active high.
5	5	FB	Feedback input — connect to GND for preset 3.3V output. A voltage divider is connected from OUT to GND to adjust output from 1.8V to 5.0V.
6	4	OUT	Output voltage pin — requires an external 10 $\mu$ F bypass capacitor (capacitance evaluated while under $V_{OUT}$ bias) for normal operation.
T	NA	Thermal Pad	Thermal Pad (MLPD package only) is for heat sinking purposes — connect to ground plane using multiple vias — not connected internally.

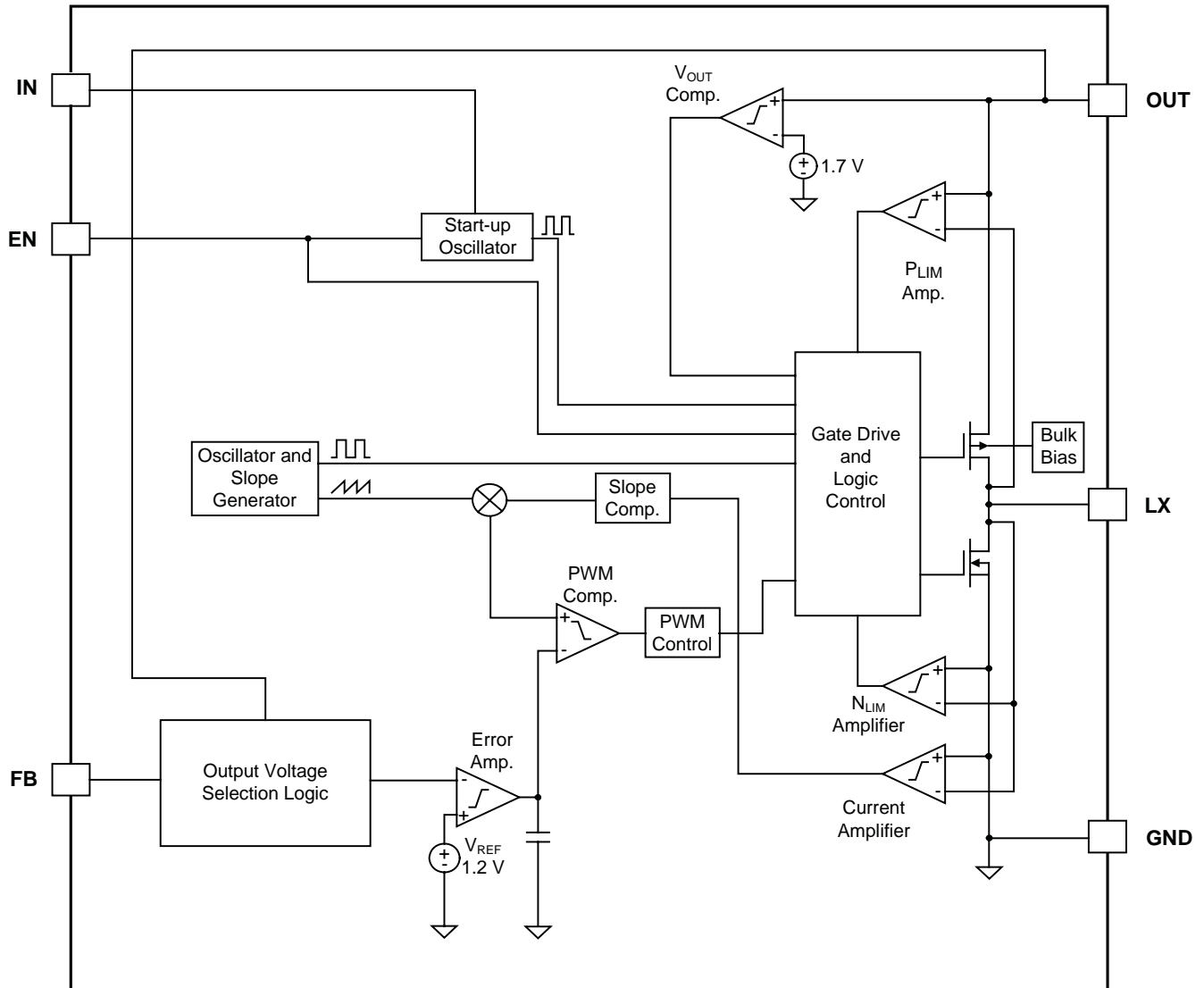
**Block Diagram**

## Applications Information

### Detailed Description

The SC120 is a synchronous step-up Pulse Width Modulated (PWM) DC-DC converter utilizing a 1.2MHz fixed frequency current mode architecture. It is designed to provide output voltages in the range 1.8V to 5.0V from an input voltage as low as 0.7V, with a (output unloaded) start up input voltage of 0.85V.

The device operates in two modes: PWM and automatic PSAVE mode. In PWM operation, the device uses pulse width modulation control to regulate the output under moderate to heavy load conditions. It switches to PSAVE mode when lightly loaded. Quiescent current consumption is as little as 50µA, into the OUT pin, when in PSAVE mode.

The regulator control circuitry is shown in the Block Diagram. It is comprised of a programmable feedback controller, an internal 1.2MHz oscillator, an n-channel Field Effect Transistor (FET) between the LX and GND pins, and a p-channel FET between the LX and OUT pins. The current flowing through both FETs is monitored and limited as required for startup, PWM operation, and PSAVE operation. An external inductor must be connected between the IN pin and the LX pin. When the n-channel FET is turned on, the LX pin is internally grounded, connecting the inductor between IN and GND. This is called the on-state. During the on-state, inductor current flows

to ground and is increasing. When the n-channel FET is turned off and the p-channel FET is turned on (known as the off-state), the inductor is then connected between IN and OUT. The (now decreasing) inductor current flows from the input to the output, boosting the output voltage above the input voltage.

### Output Voltage Selection

The SC120 output voltage can be programmed to an internally preset value or it can be programmed with external resistors. The output is internally programmed to 3.3V when the FB pin is connected to GND. Any output voltage in the range 1.8V to 5.0V can be programmed with a resistor voltage divider between OUT and the FB pin as shown in Figure 1.

The values of the resistors in the voltage divider network are chosen to satisfy the equation

$$V_{OUT} = 1.2 \times \left( 1 + \frac{R_1}{R_2} \right) \text{ (V)}$$

A large value of  $R_2$ , ideally 590kΩ or larger, is preferred for stability for  $V_{IN}$  within approximately 400mV of  $V_{OUT}$ . For lower  $V_{IN}$ , lower resistor values can be used. The values of  $R_1$  and  $R_2$  can be as large as desired to achieve low quiescent current.

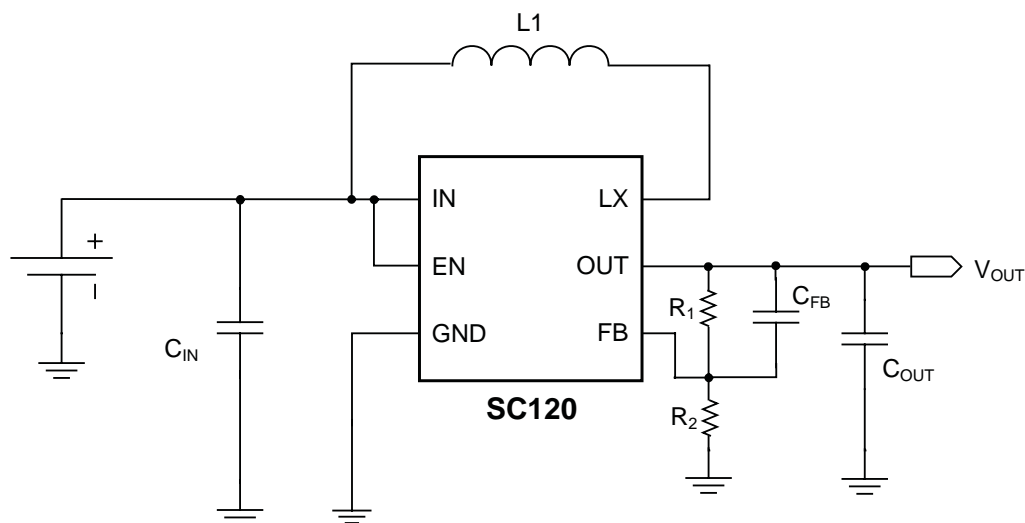

Figure 1 — Output Voltage Feedback Circuit

## Applications Information (continued)

### PWM Operation

The PWM cycle runs at a fixed frequency ( $f_{osc} = 1.2\text{MHz}$ ), with a variable duty cycle (D). PWM operation continually draws current from the input supply (except for discontinuous mode, described subsequently). During the on-state of the PWM cycle, the n-channel FET is turned on, grounding the inductor at the LX pin. This causes the current flowing from the input supply through the inductor to ground to ramp up. During the off-state, the n-channel FET is turned off and the p-channel FET (synchronous rectifier) is turned on. This causes the inductor current to flow from the input supply through the inductor into the output capacitor and load, boosting the output voltage above the input voltage. The cycle then repeats to re-energize the inductor.

Ideally, the steady state (constant load) duty cycle is determined by  $D = 1 - (V_{IN}/V_{OUT})$ , but must be greater in practice to overcome dissipative losses. The SC120 PWM controller constrains the value of D such that  $0.15 < D < 0.90$  (approximately).

The average inductor current during the off-state multiplied by (1-D) is equal to the average load current. The inductor current is alternately ramping up (on-state) and down (off-state) at a rate and amplitude determined by the inductance value, the input voltage, and the on-time ( $T_{ON} = D \times T, T = 1/f_{osc}$ ). Therefore, the instantaneous inductor current will be alternately larger and smaller than the average. If the average output current is sufficiently small, the minimum inductor current can reach zero during the off-state. If the energy stored in the inductor is depleted (the inductor current decreases to zero) during the off-state, both FETs turn off for the remainder of the off-state. If this discontinuous mode (DM) operation persists, the SC120 transitions to PSAVE operation.

### PSAVE Operation

At light loads, the SC120 will operate in PSAVE mode. At low output load, PSAVE mode will operate more efficiently than PWM mode. PSAVE mode also ensures regulation while the output load is too small to keep the PWM mode duty cycle above its minimum value, especially when  $V_{IN}$  is close to  $V_{OUT}$ . PSAVE operation is triggered by 256 consecutive cycles of DM operation in PWM mode, when the

output of the  $P_{LIM}$  amplifier falls to 0V during the off-state due to low load current.

PSAVE mode requires fewer circuit resources than PWM mode. All unused circuitry is disabled to reduce quiescent power dissipation. In PSAVE mode, the OUT pin voltage monitoring circuit remains active and the output voltage error amplifier operates as a comparator. PSAVE regulation is shown in Figure 2. When  $V_{OUT} < 1.008 \times V_{REG'}$  where  $V_{REG}$  is the programmed output voltage, a burst of fixed-period switching occurs to boost the output voltage. The n-channel FET turns on (on-state) until the inductor current rises to approximately 240mA. The n-channel FET then turns off and the p-channel FET turns on to transfer the inductor energy to the output capacitor and load for the duration of the off-state. This cycle repeats until  $V_{OUT} > 1.018 \times V_{REG'}$  at which point both FETs are turned off. The output capacitor then discharges into the load until  $V_{OUT} < 1.008 \times V_{REG'}$  and the burst cycle repeats.

When the output current increases above a predetermined level, either of two PSAVE exit conditions will force the resumption of PWM operation. The first PSAVE exit criterion is shown in Figure 2. If the PSAVE burst cycle cannot provide sufficient current to the output, the output voltage will decrease during the burst. If  $V_{OUT} < 0.98 \times V_{REG'}$  PWM operation will resume. The second PSAVE exit criterion, illustrated in Figure 3, depends on the rate of discharge of the output capacitor between PSAVE bursts. If the time between bursts is less than  $5\mu\text{s}$ , then PWM operation resumes. The output capacitance value will affect the second criterion, but not the first. Reducing the output capacitor will reduce the output load at which PSAVE mode exits to PWM mode.

Within each on/off cycle of a PSAVE burst, the rate of decrease of the inductor current during the off-state is proportional to  $(V_{OUT} - V_{IN})$ . If  $V_{IN}$  is sufficiently close to  $V_{OUT}$ , the decrease in current during the off-state may not overcome the increase in current during the minimum on-time of the on-state, approximately 100ns. This can result in the peak inductor current rising above the PSAVE mode n-channel FET current limit. (Normally, when the n-channel FET current limit is reached, the on-state ends immediately and the off-state begins. This sets the duty cycle on a cycle-by-cycle basis.) This inductor current rise

Applications Information (continued)

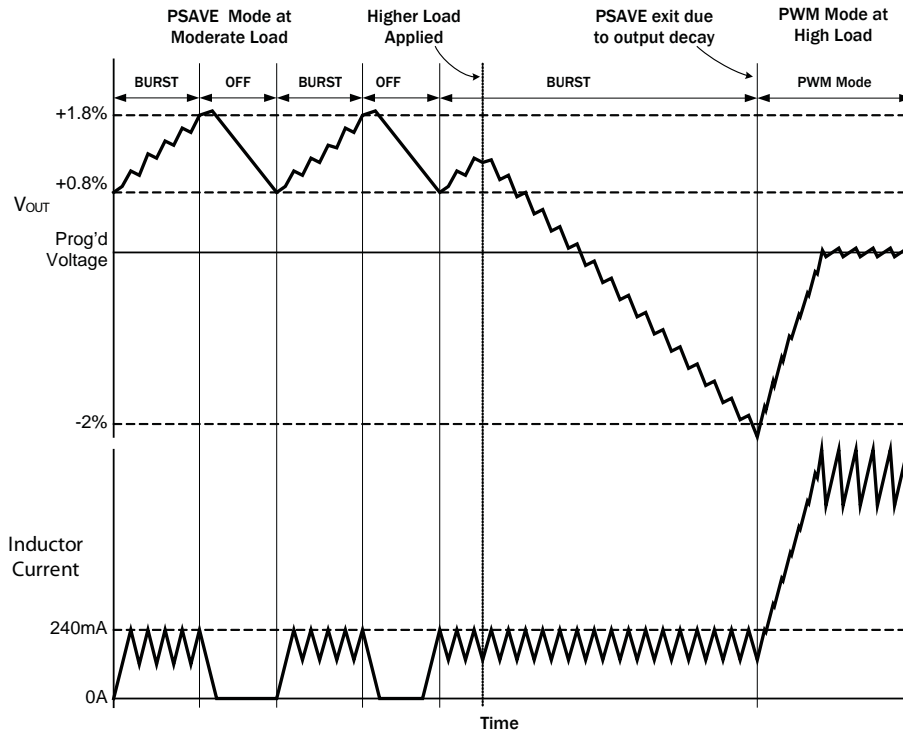

Figure 2 — PSAVE Operation With Exit to PWM Due To Output Voltage Decay

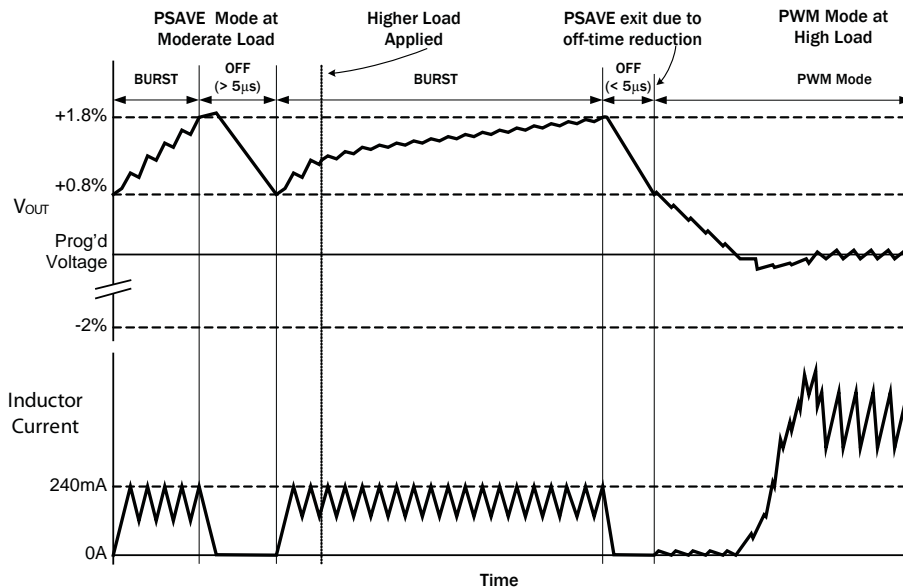

Figure 3 — PSAVE Operation With Exit to PWM Due To Off-time < 5µs

## Applications Information (continued)

accumulates with each successive cycle in the burst. The result is that the output load current that can be supported in PSAVE under this high  $V_{IN}$  condition will be greater than occurs if the 240mA current limit can be enforced. Therefore the PSAVE exit load due to the first exit criterion (Figure 2) can increase significantly. This phenomenon is advantageous. Reverting to PWM operation with high  $V_{IN}$  can result in  $V_{OUT}$  rising above  $V_{REG}$  due to the PWM minimum duty cycle. PSAVE operation avoids this voltage rise because of its hysteretic voltage-threshold on/off control. If the load remains low enough to remain in PSAVE,  $V_{IN}$  can approach and even slightly exceed  $V_{OUT}$ . To initially enter PSAVE mode, the initial startup load must be small enough to cause discontinuous mode PWM operation. This PSAVE mode startup load upper limit can be increased if needed by reducing the inductance. (Refer to the Inductor Selection section.) Sufficiently large output capacitance will prevent PSAVE exit due to the second exit criterion (Figure 3).

PSAVE  $V_{OUT}$  ripple may increase due to parasitic capacitance on the external FB pin network. If using external feedback programming, it is prudent to add a small capacitor between OUT and FB to the circuit board layout. When operating the SC120 in the final configuration in PSAVE, observe the amplitude of PSAVE ripple. If the ripple exceeds 50mV for the expected range of input voltage, a small-value capacitor should be tried. Capacitance on the order of a few picofarads is often sufficient to bring the ripple amplitude to approximately 50mV.

In the case of low  $V_{IN}$  and high  $V_{OUT}$ , larger values of CFB may be needed, perhaps 4.7pF or higher. If using the SOT23-6 package (SC120SKTRT) with low  $V_{IN}$  and high  $V_{OUT}$  at least 10pF to 12pF is recommended.

### The Enable Pin

The EN pin is a high impedance logical input that can be used to enable or disable the SC120 under processor control.  $V_{EN} < 0.2V$  will disable regulation, set the LX pin in a high-impedance state (turn off both FET switches), and turn on an active discharge device to discharge the output capacitor via the OUT pin.  $V_{EN} > 0.85V$  will enable the output. The startup sequence from the EN pin is identical to the startup sequence from the application of input power.

### Regulator Startup, Short Circuit Protection, and Current Limits

The SC120 permits power up at input voltages from 0.85V to 4.5V. Startup current limiting of the internal switching n-channel and p-channel FET power devices protects them from damage in the event of a short between OUT and GND. As the output voltage rises, progressively less-restrictive current limits are applied. This protection unavoidably prevents startup into an excessive load.

To begin, the p-channel FET between the LX and OUT pins turns on with its current limited to approximately 150mA, the short-circuit output current. When  $V_{OUT}$  approaches  $V_{IN}$  (but is still below 1.7V), the n-channel current limit is set to 350mA (the p-channel limit is disabled), the internal oscillator turns on (approximately 200kHz), and a fixed 75% duty cycle PWM operation begins. (See the section PWM Operation.) When the output voltage exceeds 1.7V, fixed frequency PWM operation begins, with the duty cycle determined by an n-channel FET peak current limit of 350mA. When this n-channel FET startup current limit is exceeded, the on-state ends immediately and the off-state begins. This determines the duty cycle on a cycle-by-cycle basis. When  $V_{OUT}$  is within 2% of the programmed regulation voltage, the n-channel FET current limit is raised to 1.2A, and normal voltage regulation PWM control begins.

Once normal voltage regulation PWM control is initiated, the output becomes independent of  $V_{IN}$  and output regulation can be maintained for  $V_{IN}$  as low as 0.7V, subject to the maximum duty cycle and peak current limits. The duty cycle must remain between 15% and 90% for the device to operate within specification.

Note that startup with a regulated active load is not the same as startup with a resistive load. The resistive load output current increases proportionately as the output voltage rises until it reaches programmed  $V_{OUT}/R_{LOAD}$ , while a regulated active load presents a constant load as the output voltage rises from 0V to programmed  $V_{OUT}$ . Note also that if the load applied to the output exceeds an applicable  $V_{OUT}$  dependent startup current limit or duty cycle limit, the criterion to advance to the next startup stage may not be achieved. In this situation startup may



## Applications Information (continued)

pause at a reduced output voltage until the load is reduced further.

### Output Overload and Recovery

When in PSAVE operation, an increasing load will eventually satisfy one of the PSAVE exit criteria and regulation will revert to PWM operation. As previously noted, the PWM steady state duty cycle is determined by  $D = 1 - (V_{IN}/V_{OUT})$ , but must be somewhat greater in practice to overcome dissipative losses. As the output load increases, the dissipative losses also increase. The PWM controller must increase the duty cycle to compensate. Eventually, one of two overload conditions will occur, determined by  $V_{IN}$ ,  $V_{OUT}$  and the overall dissipative losses due to the output load current. Either the maximum duty cycle of 90% will be reached or the n-channel FET 1.2A (nominal) peak current limit will be reached, which effectively limits the duty cycle to a lower value. Above that load, the output voltage will decrease rapidly and in reverse order the startup current limits will be invoked as the output voltage falls through its various voltage thresholds. How far the output voltage drops depends on the load voltage vs. current characteristic.

A reduction in input voltage, such as a discharging battery, will lower the load current at which overload occurs. Lower input voltage increases the duty cycle required to produce a given output voltage. And lower input voltage also increases the input current to maintain the input power, which increases dissipative losses and further increases the required duty cycle. Therefore an increase in load current or a decrease in input voltage can result in output overload. Once an overload has occurred, the load must be decreased to permit recovery. The conditions required for overload recovery are identical to those required for successful initial startup.

### Anti-ringing Circuitry

In PWM operation, the n-channel and p-channel FETs are simultaneously turned off when the inductor current reaches zero. They remain off for the zero-inductor-current portion of the off-state. Note that discontinuous mode is a marginal-load condition, which if persistent will trigger a transition to PSAVE operation.

When both FET switches are simultaneously turned off, an internal switch between the IN and LX pins is closed, pro-

viding a moderate resistance path across the inductor to dampen the oscillations at the LX pin. This effectively reduces EMI that can develop from the resonant circuit formed by the inductor and the drain capacitance at LX.

The anti-ringing circuitry is disabled between PSAVE bursts.

### Component Selection

The SC120 provides optimum performance when a 4.7μH inductor is used with a 10μF output capacitor. Different component values can be used to modify PSAVE exit or entry loads, modify output voltage ripple in PWM mode, improve transient response, or to reduce component size or cost.

### Inductor Selection

The inductance value primarily affects the amplitude of inductor current ripple ( $\Delta I_L$ ). Reducing inductance increases  $\Delta I_L$ . This raises the inductor peak current,  $I_{L-max} = I_{L-avg} + \Delta I_L/2$ , where  $I_{L-avg}$  is the inductor current averaged over a full on/off cycle.  $I_{L-max}$  is subject to the n-channel FET current limit  $I_{LIM(N)}$ , therefore reducing the inductance may lower the output overload current threshold. Increasing  $\Delta I_L$  also lowers the inductor minimum current,  $I_{L-min} = I_{L-avg} - \Delta I_L/2$ , thus raising the PSAVE entry load current threshold. This is the output load below which  $I_{L-min} = 0$ , the boundary between continuous mode and discontinuous mode PWM regulation, which signals the SC120 controller to switch to PSAVE operation. In the extreme case of  $V_{IN}$  approaching  $V_{OUT}$ , smaller inductance can also *reduce* the PSAVE inductor burst-envelope current ripple and voltage ripple.

Equate input power to output power, note that input current equals inductor current, and average over a full PWM switching cycle to obtain

$$I_{L-avg} = \frac{1}{\eta} \times \frac{V_{OUT} \times I_{OUT}}{V_{IN}}$$

where  $\eta$  is efficiency.

$\Delta I_L$  is the inductor (and thus the input) peak-to-peak current. Neglecting the n-channel FET  $R_{DS-ON}$  and the inductor DCR, for duty cycle  $D$ , and with  $T = 1/f_{osc}$



## Applications Information (continued)

$$\Delta I_{L-on} = \frac{1}{L} \int_0^{DT} V_{IN} dt = \frac{V_{IN} \times D \times T}{L}$$

This is the change in  $I_L$  during the on-state. During the off-state, again neglecting the p-channel FET  $R_{DS-ON}$  and the inductor DCR,

$$\Delta I_{L-off} = \frac{1}{L} \int_{DT}^T (V_{IN} - V_{OUT}) dt = \frac{(V_{IN} - V_{OUT}) \times T}{L} (1-D)$$

Note that this is a negative quantity, since  $V_{OUT} > V_{IN}$  and  $0 < D < 1$ . For a constant load in steady-state, the inductor current must satisfy  $\Delta I_{L-on} + \Delta I_{L-off} = 0$ . Substituting the two expressions and solving for D, obtain  $D = 1 - V_{IN}/V_{OUT}$ . Using this expression, and the positive valued expression  $\Delta I_L = \Delta I_{L-on}$  for current ripple amplitude, obtain expanded expression for  $I_{L-max}$  and  $I_{L-min}$ .

$$I_{L-max,min} = \frac{V_{OUT} \times I_{OUT}}{V_{IN} \times \eta} \pm \frac{T}{2 \times L} \times \frac{V_{IN}}{V_{OUT}} \times (V_{OUT} - V_{IN})$$

If the value of  $I_{OUT}$  decreases until  $I_{L-min} = 0$ , which is the boundary of continuous and discontinuous PWM operation, the SC120 will transition from PWM operation to PSAVE operation. Define this value of  $I_{OUT}$  as  $I_{PSAVE-entry}$ . Setting the expression for  $I_{L-min}$  to 0 and solving,

$$I_{PSAVE-entry} = \frac{\eta \times T}{2 \times L} \left( \frac{V_{IN}}{V_{OUT}} \right)^2 (V_{OUT} - V_{IN})$$

The programmed value of  $V_{OUT}$  is constant.  $I_{PSAVE-entry}$  is a polynomial function of  $V_{IN}$ . Equating  $dI_{PSAVE-entry}/dV_{IN} = 0$  and solving for  $V_{IN}$  reveals that there is one non-zero extremum of this function, a maximum, at  $V_{IN} = \frac{2}{3} V_{OUT}$ \*. Applying this value of  $V_{IN}$

$$I_{PSAVE-entry-max} = \frac{\eta \times T}{L} \times \frac{2}{27} \times V_{OUT}$$

The value of the inductor determines the PSAVE entry output load current for a given  $V_{IN}$ . Evaluate  $I_{PSAVE-entry}$  at the

\* For simplicity, efficiency ( $\eta$ ) is represented as a constant. But efficiency, itself a function of  $V_{IN}$ , decreases with decreasing  $V_{IN}$  (and decreases with increasing temperature). Therefore at a given temperature, the input voltage that produces the maximum PSAVE entry load current will be slightly greater than  $\frac{2}{3}$  of  $V_{OUT}$ .

smallest and largest expected values of  $V_{IN}$ . If the input range includes  $V_{IN} = \frac{2}{3} V_{OUT}$ , also determine  $I_{PSAVE-entry-max}$ . Note that at high  $V_{IN}$  ( $V_{IN}$  close to  $V_{OUT}$ ) PSAVE exit may require an unusually high output load current. In this case, PSAVE re-entry may be of little concern. So if the largest  $V_{IN}$  exceeds approximately 90% of  $V_{OUT}$ , instead evaluate PSAVE entry at  $V_{IN} = 0.9V_{OUT}$ .

To ensure that  $I_{PSAVE-entry-max}$  will be less than the PSAVE exit current, evaluate the PSAVE-PWM mode transitions while applying increasing and decreasing loads with  $V_{IN}$  at and above  $\frac{2}{3} V_{OUT}$ . This should be done at the application's lowest specified ambient temperature as well as at room temperature. If the PSAVE exit current is not sufficiently greater than the PSAVE entry current, the separation can be enhanced by increasing the output capacitance to raise  $I_{PSAVE-exit}$  due to the 5 $\mu$ s off-time criterion (see Figure 3), or by increasing the inductor value to reduce  $I_{PSAVE-entry}$ .

The inductor selection should also consider the n-channel FET current limit for the expected range of input voltage and output load current. The largest  $I_{L-avg}$  will occur at the expected smallest  $V_{IN}$  and largest  $I_{OUT}$ . Determine the largest allowable  $\Delta I_L$ , based on the largest expected  $I_{L-avg}$ , the minimum n-channel FET current limit, and the inductor tolerance. Ensure that in the worst case,  $I_{L-avg} + \Delta I_L/2 < I_{LIM(N)}$ .

These calculations include the parameter  $\eta$ , efficiency. Efficiency varies with  $V_{IN}$ ,  $I_{OUT}$  and temperature. Estimate  $\eta$  using the plots provided in this datasheet, or from experimental data, at the operating condition of interest when computing the effect of a new inductor value on PSAVE entry and I-limit margin.

Any chosen inductor should have low DCR, compared to the  $R_{DS-ON}$  of the FET switches, to maintain efficiency, though for  $DCR \ll R_{DS-ON}$ , further reduction in DCR will provide diminishing benefit. The inductor  $I_{SAT}$  value should exceed the expected  $I_{L-max}$ . The inductor self-resonant frequency should exceed  $5 \times f_{osc}$ . Any inductor with these properties should provide satisfactory performance.

$L = 4.7\mu H$  should perform well for most applications. For high  $V_{OUT}$  (4.0V to 5.0V), and relatively high  $V_{IN}$  (3.3V and above),  $L = 6.8\mu H$ , along with a larger output capacitance or larger-package output capacitor (for better V-bias per-

## Applications Information (continued)

formance), will ensure correct mode-switching behavior.

For very low  $V_{IN}$  (0.7V to 0.8V) such as is obtained with a nearly-depleted single-cell alkaline battery), a smaller value of inductance will help to ensure that PWM mode will switch to PSAVE mode as the load decreases. This consideration may be of little importance in most applications, as there is little energy remaining in such a deeply discharged battery.

The following table lists the manufacturers of recommended inductor options. The specification values shown are simplified approximations or averages of many device parameters under various test conditions. See manufacturers' documentation for full performance data.

Manufacturer/ Part #	Value ( $\mu$ H)	DCR ( $\Omega$ )	Rated Current (mA)	Tolerance (%)	Dimensions LxWxH (mm)
Murata LQM31PN4R7M00	4.7	0.3	700	20	3.2 x 1.6 x 0.95
Coilcraft XFL2006-472	4.7	0.7	500	20	2 x 2 x 0.6

### Capacitor Selection

Input and output capacitors must be chosen carefully to ensure that they are of the correct value and rating. The output capacitor requires a minimum capacitance value of 10 $\mu$ F at the programmed output voltage to ensure stability over the full operating range, and to ensure positive mode-switching hysteresis. The DC bias must be included in capacitor derating to ensure the required effective capacitance is provided, especially when considering small package-size capacitors. For example, a 10 $\mu$ F 0805 capacitor may provide sufficient capacitance at low output voltages but may be too low at higher output voltages. Therefore, a higher capacitance value may be required to provide the minimum of 10 $\mu$ F at these higher output voltages. Additional output capacitance may be required for  $V_{IN}$  close to  $V_{OUT}$  to reduce ripple in PSAVE mode, to increase the PSAVE exit threshold for high  $V_{IN}$ , and to ensure stability in PWM mode, especially at higher output load currents.

Low ESR capacitors such as X5R or X7R type ceramic capacitors are recommended for input bypassing and output filtering. Low-ESR tantalum capacitors are not recommended due to possible reduction in capacitance seen

at the switching frequency of the SC120. Ceramic capacitors of type Y5V are not recommended as their temperature coefficients and large capacitance tolerance make them unsuitable for this application. The following table lists recommended capacitors. For smaller values and smaller packages, it may be necessary to use multiple devices in parallel, especially for  $C_{OUT}$ .

Manufacturer/ Part Number	Value ( $\mu$ F)	Rated Volt- age (VDC)	Type	Case Size	Case Height (mm)
Murata GRM21BR60J226ME39B	22	6.3	X5R	0805	1.25
Murata GRM31CR71A226KE15L	22	10	X7R	1206	1.6
Murata GRM185R60G475ME15	4.7	4	X5R	0603	0.5
TDK C2012X5R1A226M	22	10	X5R	0805	0.85
Taiyo Yuden JMK212BJ226MG-T	22	20	X5R	0805	1.25

### PCB Layout Considerations

Poor layout can degrade the performance of the DC-DC converter and can contribute to EMI problems, ground bounce, and resistive voltage losses. Poor regulation and instability can result.

The following simple design rules can be implemented to ensure good layout:

- Place the inductor and filter capacitors as close to the device as possible and use short wide traces between the power components.
- Route the output voltage feedback path away from the inductor and LX node to minimize noise and magnetic interference.
- Maximize ground metal on the component side to improve the return connection and thermal dissipation. Separation between the LX node and GND should be maintained to avoid coupling capacitance between the LX node and the ground plane.
- Use a ground plane with several vias connecting to the component side ground to further reduce noise interference on sensitive circuit nodes.

A layout drawing for the MLP package is shown in Figure 4 and a layout drawing for the SOT23 package is shown in Figure 5.

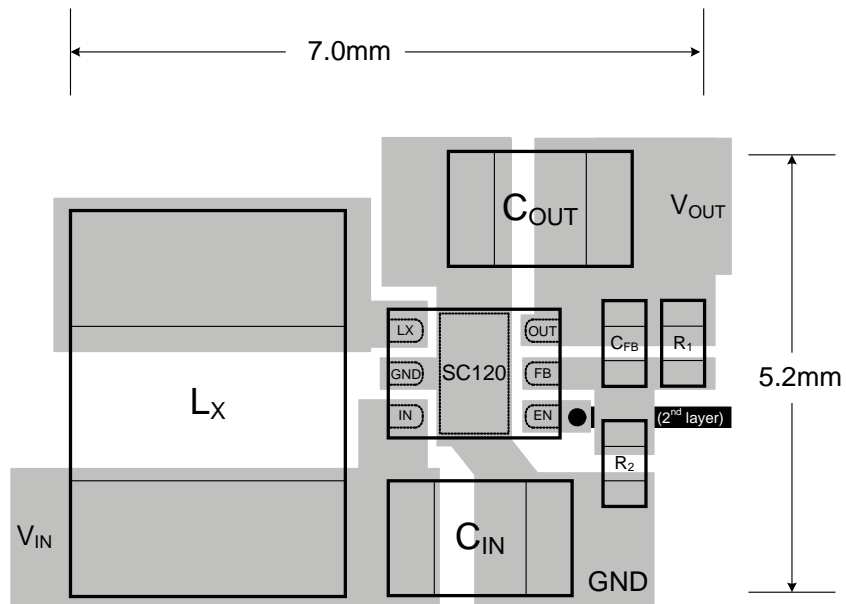
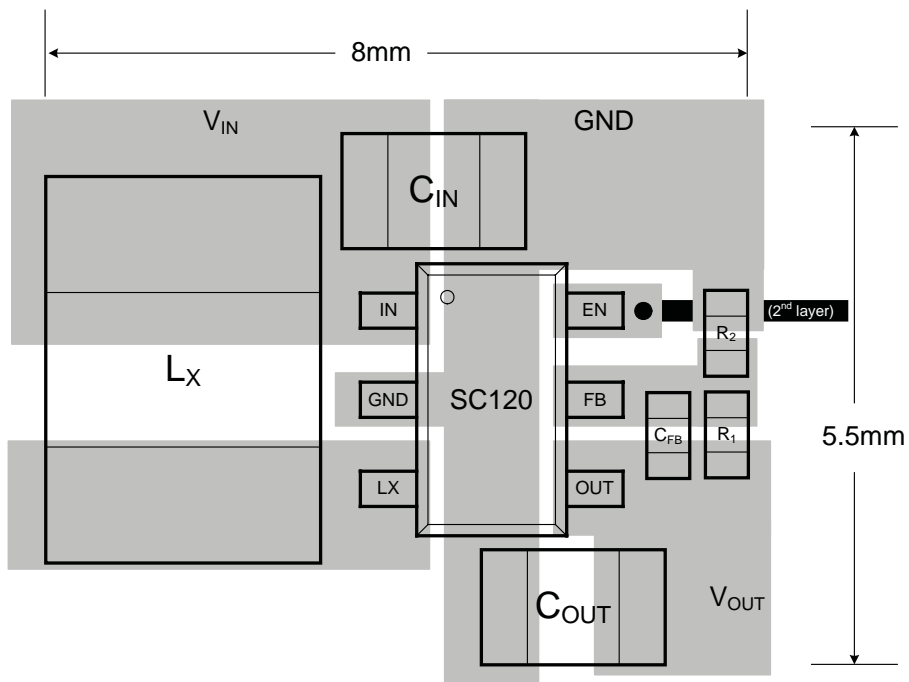
**Applications Information (continued)**

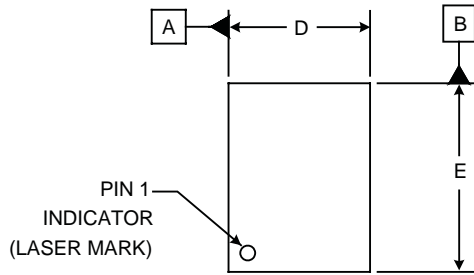
**Figure 4 — Layout Drawing for MLP package**

**Figure 5 — Layout Drawing for SOT23-6 package**

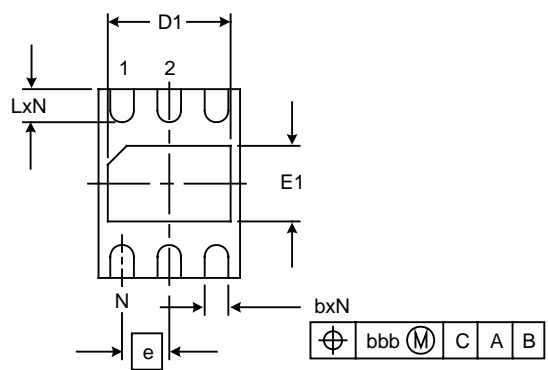
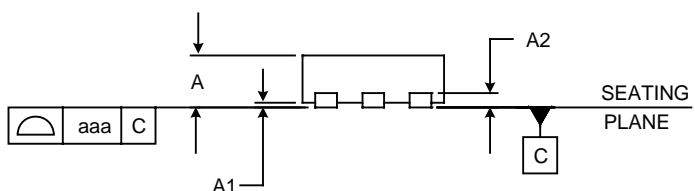
**Outline Drawing — MLPD-UT-6 1.5x2**

DIM	DIMENSIONS					
	INCHES			MILLIMETERS		
	MIN	NOM	MAX	MIN	NOM	MAX
A	.020	-	.024	0.50	-	0.60
A1	.000	-	.002	0.00	-	0.05
A2	(.006)			(.152)		
b	.007	.010	.012	0.18	0.25	0.30
D	.055	.059	.063	1.40	1.50	1.60
D1	.035	-	.055	0.90	-	1.40
E	.075	.079	.083	1.90	2.00	2.10
E1	.026	.031	.035	0.65	0.80	0.90
e	.020 BSC			0.50 BSC		
L	.012	.014	.016	0.30	0.35	0.40
N	6			6		
aaa	.003			0.08		
bbb	.004			0.10		

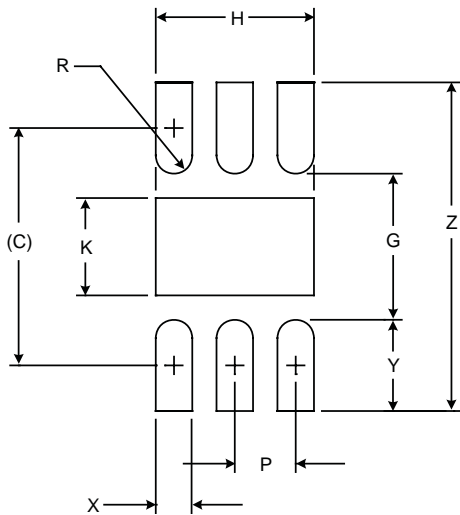
**NOTES:**

1. CONTROLLING DIMENSIONS ARE IN MILLIMETERS (ANGLES IN DEGREES).
2. COPLANARITY APPLIES TO THE EXPOSED PAD AS WELL AS TERMINALS.

**Land Pattern — MLPD-UT-6 1.5x2**

DIMENSIONS		
DIM	INCHES	MILLIMETERS
C	(.077)	(1.95)
G	.047	1.20
H	.051	1.30
K	.031	0.80
P	.020	0.50
R	.006	0.15
X	.012	0.30
Y	.030	0.75
Z	.106	2.70

**NOTES:**

1. CONTROLLING DIMENSIONS ARE IN MILLIMETERS (ANGLES IN DEGREES).
2. THIS LAND PATTERN IS FOR REFERENCE PURPOSES ONLY.  
CONSULT YOUR MANUFACTURING GROUP TO ENSURE YOUR COMPANY'S MANUFACTURING GUIDELINES ARE MET.
3. THERMAL VIAS IN THE LAND PATTERN OF THE EXPOSED PAD SHALL BE CONNECTED TO A SYSTEM GROUND PLANE.  
FAILURE TO DO SO MAY COMPROMISE THE THERMAL AND/OR FUNCTIONAL PERFORMANCE OF THE DEVICE.

Outline Drawing — SOT23-6

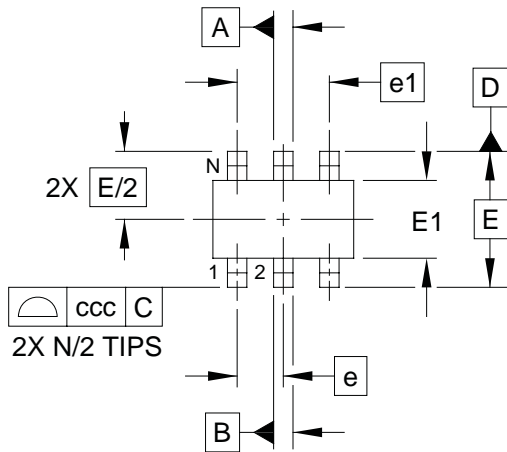

DIMENSIONS			
DIM	MILLIMETERS		
	MIN	NOM	MAX
A	0.90	-	1.45
A1	0.00	-	0.15
A2	0.90	1.15	1.30
b	0.25	-	0.50
c	0.08	-	0.22
D	2.80	2.90	3.10
E1	1.50	1.60	1.75
E	2.80 BSC		
e	0.95 BSC		
e1	1.90 BSC		
L	0.30	0.45	0.60
L1	(0.60)		
N	6		
$\theta 1$	0°	-	10°
aaa	0.10		
bbb	0.20		
ccc	0.20		

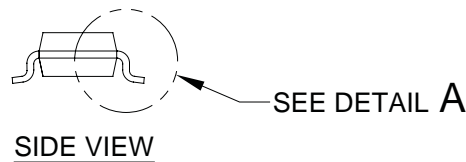
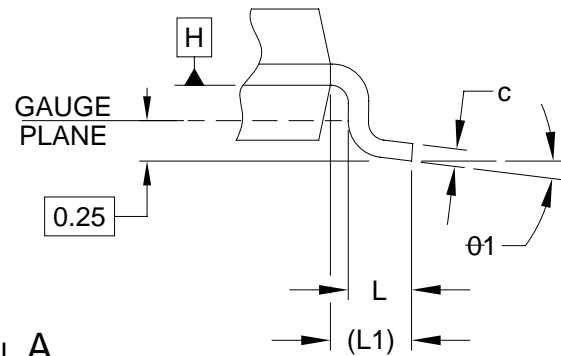
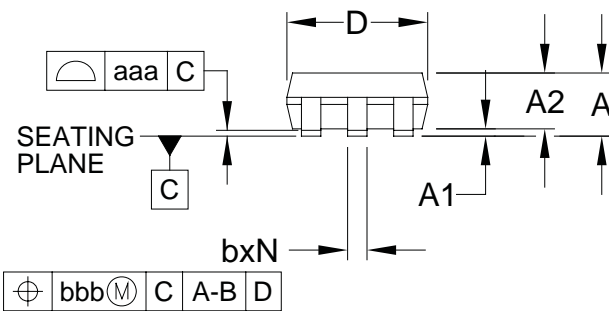

NOTES:

1. CONTROLLING DIMENSIONS ARE IN MILLIMETERS (ANGLES IN DEGREES).
2. DATUMS **-A-** AND **-B-** TO BE DETERMINED AT DATUM PLANE **-H-**
3. DIMENSIONS "E1" AND "D" DO NOT INCLUDE MOLD FLASH, PROTRUSIONS OR GATE BURRS.

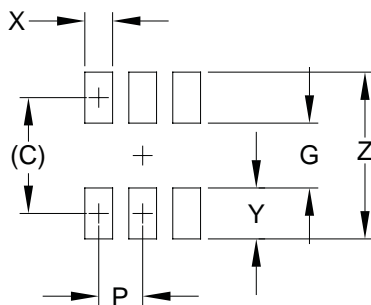
**Land Pattern — SOT23-6**

DIMENSIONS	
DIM	MILLIMETERS
C	(2.50)
G	1.40
P	0.95
X	0.60
Y	1.10
Z	3.60

**NOTES:**

1. CONTROLLING DIMENSIONS ARE IN MILLIMETERS (ANGLES IN DEGREES).
2. THIS LAND PATTERN IS FOR REFERENCE PURPOSES ONLY. CONSULT YOUR MANUFACTURING GROUP TO ENSURE YOUR COMPANY'S MANUFACTURING GUIDELINES ARE MET.



© Semtech 2010

All rights reserved. Reproduction in whole or in part is prohibited without the prior written consent of the copyright owner. The information presented in this document does not form part of any quotation or contract, is believed to be accurate and reliable and may be changed without notice. No liability will be accepted by the publisher for any consequence of its use. Publication thereof does not convey nor imply any license under patent or other industrial or intellectual property rights. Semtech assumes no responsibility or liability whatsoever for any failure or unexpected operation resulting from misuse, neglect improper installation, repair or improper handling or unusual physical or electrical stress including, but not limited to, exposure to parameters beyond the specified maximum ratings or operation outside the specified range.

SEMTECH PRODUCTS ARE NOT DESIGNED, INTENDED, AUTHORIZED OR WARRANTED TO BE SUITABLE FOR USE IN LIFE-SUPPORT APPLICATIONS, DEVICES OR SYSTEMS OR OTHER CRITICAL APPLICATIONS. INCLUSION OF SEMTECH PRODUCTS IN SUCH APPLICATIONS IS UNDERSTOOD TO BE UNDERTAKEN SOLELY AT THE CUSTOMER'S OWN RISK. Should a customer purchase or use Semtech products for any such unauthorized application, the customer shall indemnify and hold Semtech and its officers, employees, subsidiaries, affiliates, and distributors harmless against all claims, costs damages and attorney fees which could arise.

Notice: All referenced brands, product names, service names and trademarks are the property of their respective owners.

## Contact Information

---

Semtech Corporation  
Power Management Products Division  
200 Flynn Road, Camarillo, CA 93012  
Phone: (805) 498-2111 Fax: (805) 498-3804

[www.semtech.com](http://www.semtech.com)