

BUZ 32 H3045A

SIPMOS[®] Power Transistor

- N channel
- Enhancement mode
- Avalanche-rated
- Pb-free lead plating; RoHS compliant
- Halogen-free according to IEC61249-2-21

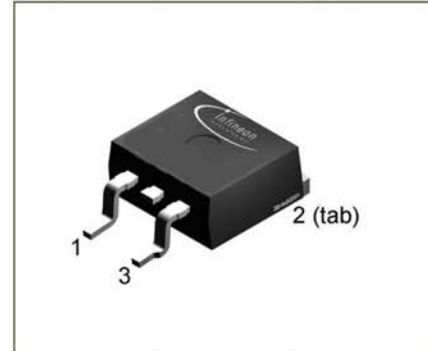

Pin 1	Pin 2	Pin 3
G	D	S

Type	V _{DS}	I _D	R _{DS(on)}	Package	Pb-free
BUZ32 H3045A	200 V	9.5 A	0.4 Ω	PG-T0263-3	Yes

Maximum Ratings

Parameter	Symbol	Values	Unit
Continuous drain current $T_C = 29\text{ °C}$	I_D	9.5	A
Pulsed drain current $T_C = 25\text{ °C}$	I_{Dpuls}	38	
Avalanche current, limited by T_{jmax}	I_{AR}	9.5	
Avalanche energy, periodic limited by T_{jmax}	E_{AR}	6.5	mJ
Avalanche energy, single pulse $I_D = 9.5\text{ A}$, $V_{DD} = 50\text{ V}$, $R_{GS} = 25\text{ Ω}$ $L = 2\text{ mH}$, $T_j = 25\text{ °C}$	E_{AS}	120	
Gate source voltage	V_{GS}	± 20	V
Power dissipation $T_C = 25\text{ °C}$	P_{tot}	75	W
Operating temperature	T_j	-55 ... + 150	°C
Storage temperature	T_{stg}	-55 ... + 150	
Thermal resistance, chip case	R_{thJC}	≤ 1.67	K/W
Thermal resistance, chip to ambient	R_{thJA}	75	
DIN humidity category, DIN 40 040		E	
IEC climatic category, DIN IEC 68-1		55 / 150 / 56	

Electrical Characteristics, at $T_j = 25^\circ\text{C}$, unless otherwise specified

Parameter	Symbol	Values			Unit
		min.	typ.	max.	
Static Characteristics					
Drain- source breakdown voltage $V_{GS} = 0\text{ V}, I_D = 0.25\text{ mA}, T_j = 25^\circ\text{C}$	$V_{(BR)DSS}$	200	-	-	V
Gate threshold voltage $V_{GS}=V_{DS}, I_D = 1\text{ mA}$	$V_{GS(th)}$	2.1	3	4	
Zero gate voltage drain current $V_{DS} = 200\text{ V}, V_{GS} = 0\text{ V}, T_j = 25^\circ\text{C}$ $V_{DS} = 200\text{ V}, V_{GS} = 0\text{ V}, T_j = 125^\circ\text{C}$	I_{DSS}	-	0.1 10	1 100	μA
Gate-source leakage current $V_{GS} = 20\text{ V}, V_{DS} = 0\text{ V}$	I_{GSS}	-	10	100	nA
Drain-Source on-resistance $V_{GS} = 10\text{ V}, I_D = 6\text{ A}$	$R_{DS(on)}$	-	0.3	0.4	Ω

Electrical Characteristics, at $T_j = 25^\circ\text{C}$, unless otherwise specified

Parameter	Symbol	Values			Unit
		min.	typ.	max.	
Dynamic Characteristics					
Transconductance $V_{DS} \geq 2 \cdot I_D \cdot R_{DS(on)max}$, $I_D = 6\text{ A}$	g_{fs}	3	4.6	-	S
Input capacitance $V_{GS} = 0\text{ V}$, $V_{DS} = 25\text{ V}$, $f = 1\text{ MHz}$	C_{iss}	-	400	530	pF
Output capacitance $V_{GS} = 0\text{ V}$, $V_{DS} = 25\text{ V}$, $f = 1\text{ MHz}$	C_{oss}	-	85	130	
Reverse transfer capacitance $V_{GS} = 0\text{ V}$, $V_{DS} = 25\text{ V}$, $f = 1\text{ MHz}$	C_{rss}	-	45	70	
Turn-on delay time $V_{DD} = 30\text{ V}$, $V_{GS} = 10\text{ V}$, $I_D = 3\text{ A}$ $R_{GS} = 50\ \Omega$	$t_{d(on)}$	-	10	15	ns
Rise time $V_{DD} = 30\text{ V}$, $V_{GS} = 10\text{ V}$, $I_D = 3\text{ A}$ $R_{GS} = 50\ \Omega$	t_r	-	40	60	
Turn-off delay time $V_{DD} = 30\text{ V}$, $V_{GS} = 10\text{ V}$, $I_D = 3\text{ A}$ $R_{GS} = 50\ \Omega$	$t_{d(off)}$	-	55	75	
Fall time $V_{DD} = 30\text{ V}$, $V_{GS} = 10\text{ V}$, $I_D = 3\text{ A}$ $R_{GS} = 50\ \Omega$	t_f	-	30	40	

Electrical Characteristics, at $T_j = 25^\circ\text{C}$, unless otherwise specified

Parameter	Symbol	Values			Unit
		min.	typ.	max.	
Reverse Diode					
Inverse diode continuous forward current $T_C = 25^\circ\text{C}$	I_S	-	-	9.5	A
Inverse diode direct current, pulsed $T_C = 25^\circ\text{C}$	I_{SM}	-	-	38	
Inverse diode forward voltage $V_{GS} = 0\text{ V}, I_F = 19\text{ A}$	V_{SD}	-	1.4	1.7	V
Reverse recovery time $V_R = 100\text{ V}, I_F = I_S, di_F/dt = 100\text{ A}/\mu\text{s}$	t_{rr}	-	200	-	ns
Reverse recovery charge $V_R = 100\text{ V}, I_F = I_S, di_F/dt = 100\text{ A}/\mu\text{s}$	Q_{rr}	-	0.6	-	μC

Power dissipation

$P_{tot} = f(T_C)$

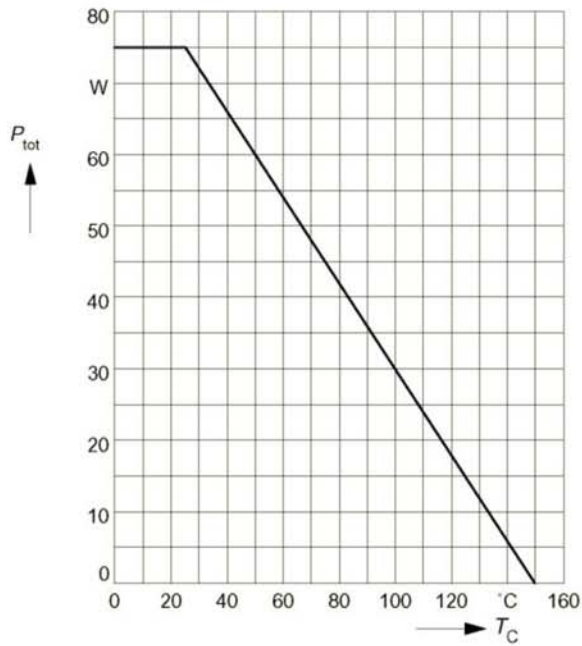

Drain current

$I_D = f(T_C)$

parameter: $V_{GS} \geq 10$ V

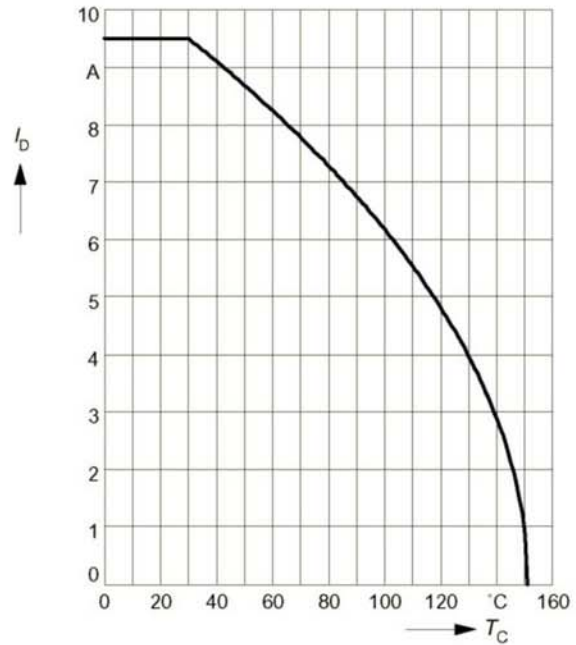

Safe operating area

$I_D = f(V_{DS})$

parameter: $D = 0.01$, $T_C = 25^\circ\text{C}$

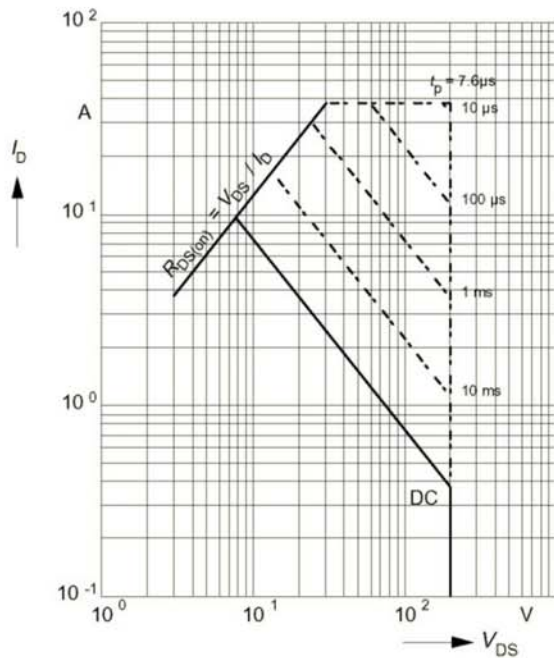

Transient thermal impedance

$Z_{thJC} = f(t_p)$

parameter: $D = t_p / T$

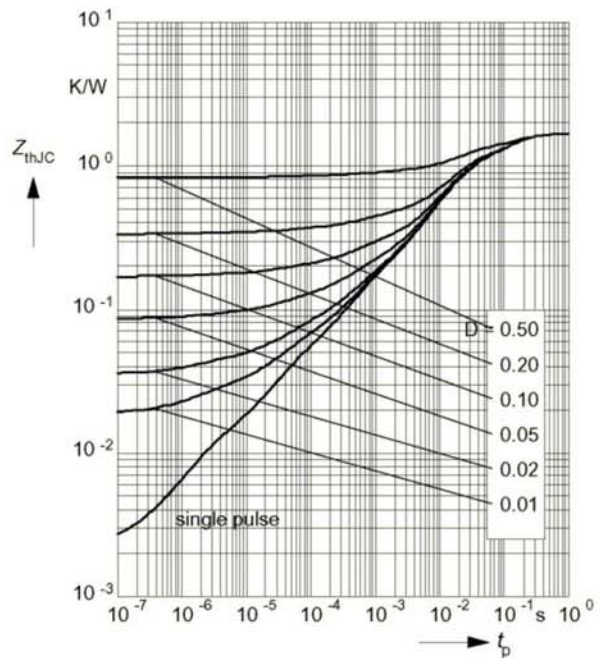

Typ. output characteristics

$I_D = f(V_{DS})$
parameter: $t_p = 80 \mu s$

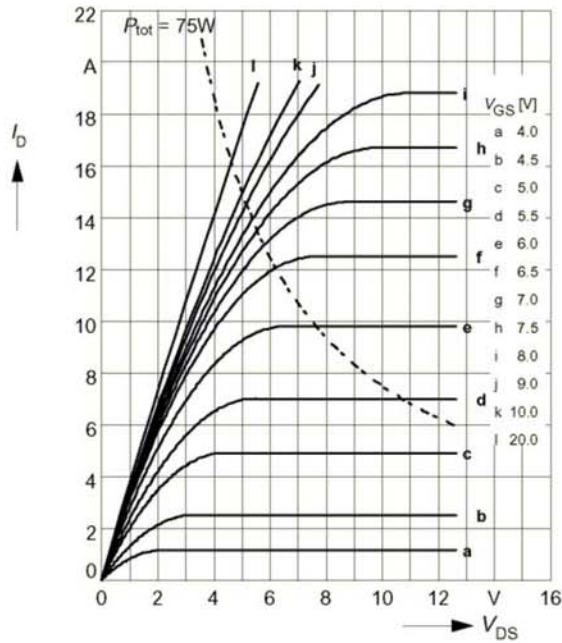

Typ. drain-source on-resistance

$R_{DS(on)} = f(I_D)$
parameter: V_{GS}

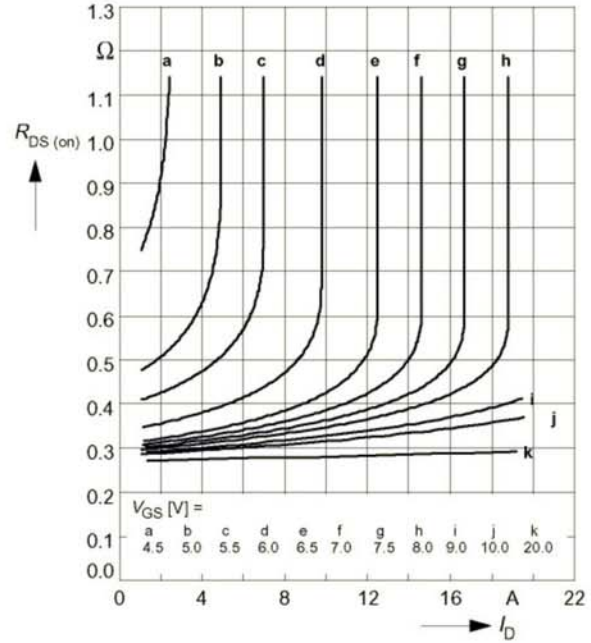

Typ. transfer characteristics $I_D = f(V_{GS})$

parameter: $t_p = 80 \mu s$
 $V_{DS} \geq 2 \times I_D \times R_{DS(on)max}$

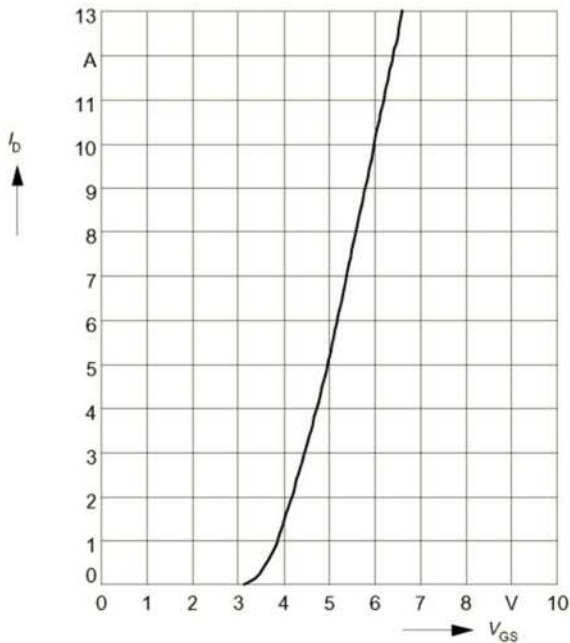

Typ. forward transconductance $g_{fs} = f(I_D)$

parameter: $t_p = 80 \mu s$,
 $V_{DS} \geq 2 \times I_D \times R_{DS(on)max}$

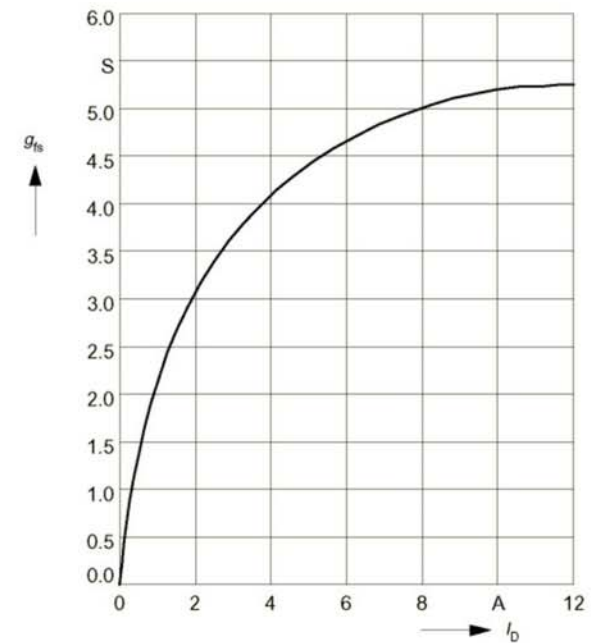

Drain-source on-resistance

$R_{DS(on)} = f(T_j)$

parameter: $I_D = 6\text{ A}$, $V_{GS} = 10\text{ V}$

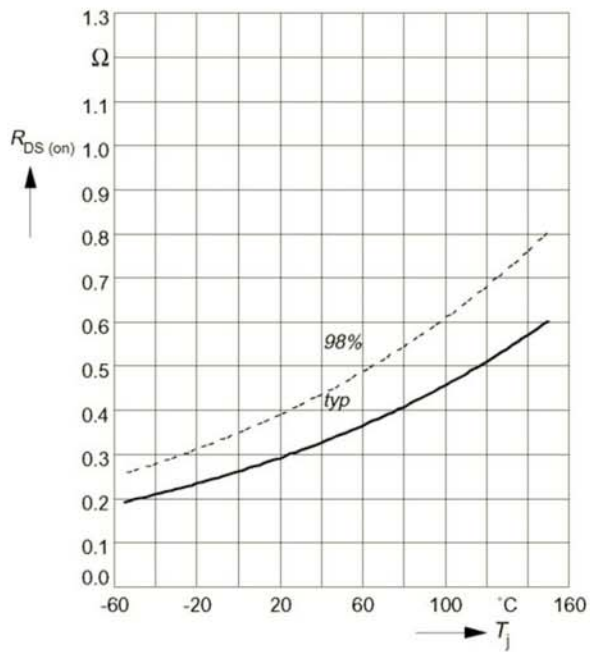

Gate threshold voltage

$V_{GS(th)} = f(T_j)$

parameter: $V_{GS} = V_{DS}$, $I_D = 1\text{ mA}$

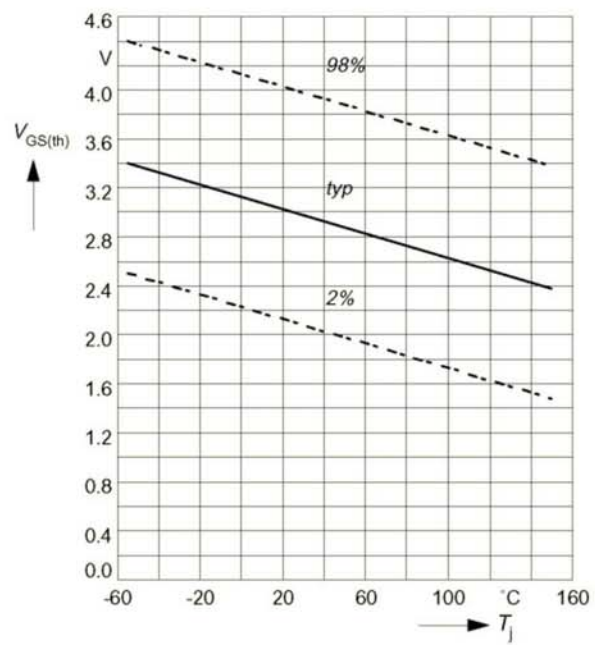

Typ. capacitances

$C = f(V_{DS})$

parameter: $V_{GS} = 0\text{ V}$, $f = 1\text{ MHz}$

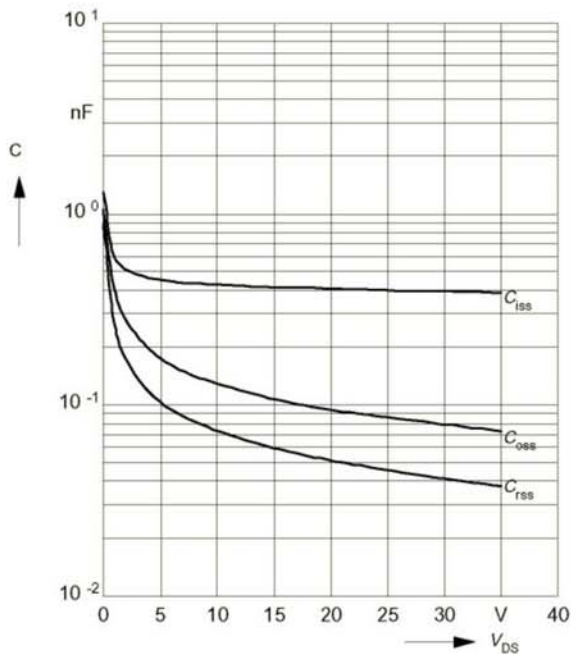

Forward characteristics of reverse diode

$I_F = f(V_{SD})$

parameter: T_j , $t_p = 80\text{ }\mu\text{s}$

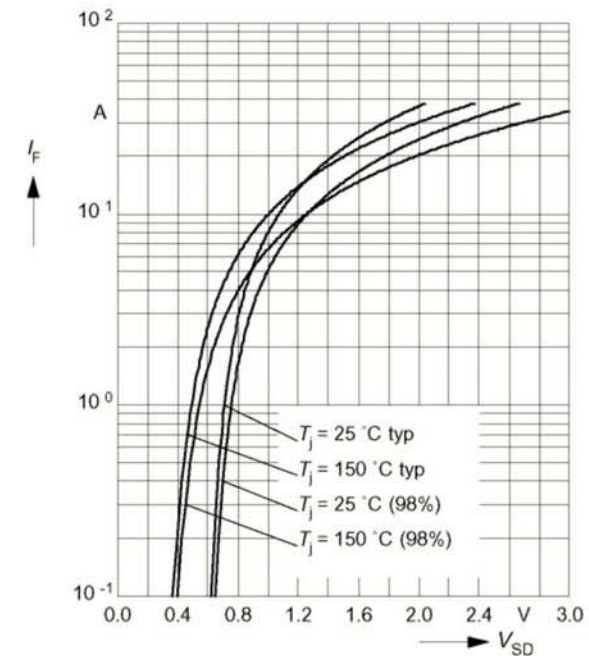

Avalanche energy $E_{AS} = f(T_j)$
 parameter: $I_D = 9.5 \text{ A}$, $V_{DD} = 50 \text{ V}$
 $R_{GS} = 25 \Omega$, $L = 2 \text{ mH}$

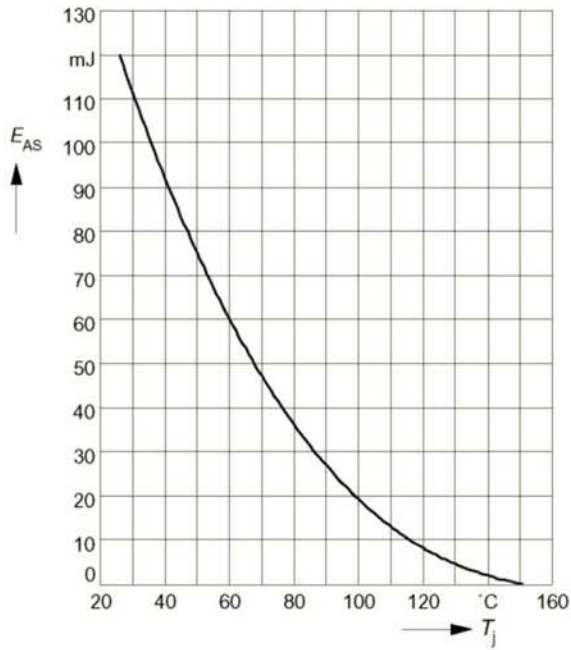

Typ. gate charge
 $V_{GS} = f(Q_{Gate})$
 parameter: $I_{D \text{ puls}} = 14 \text{ A}$

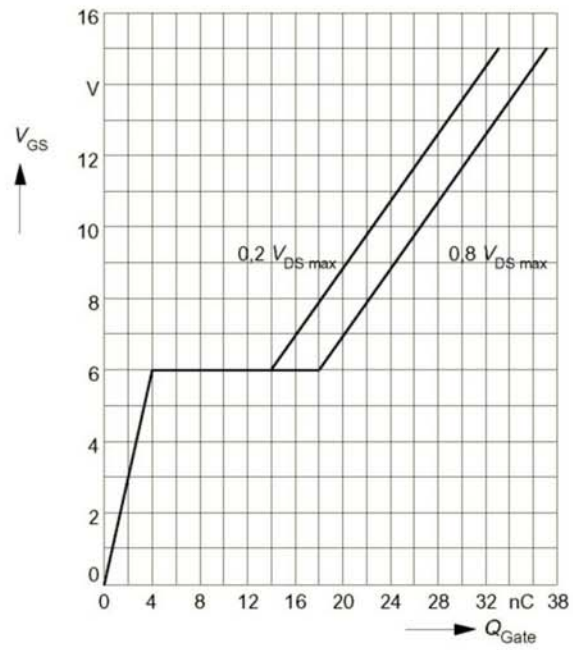

Drain-source breakdown voltage
 $V_{(BR)DSS} = f(T_j)$

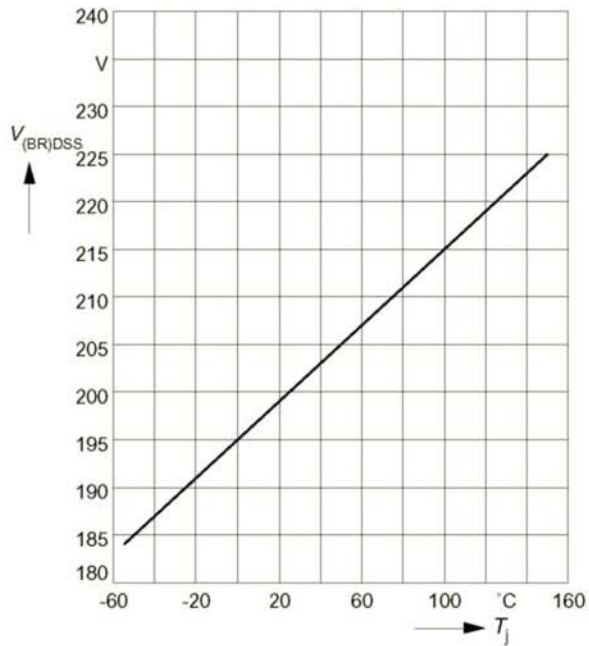

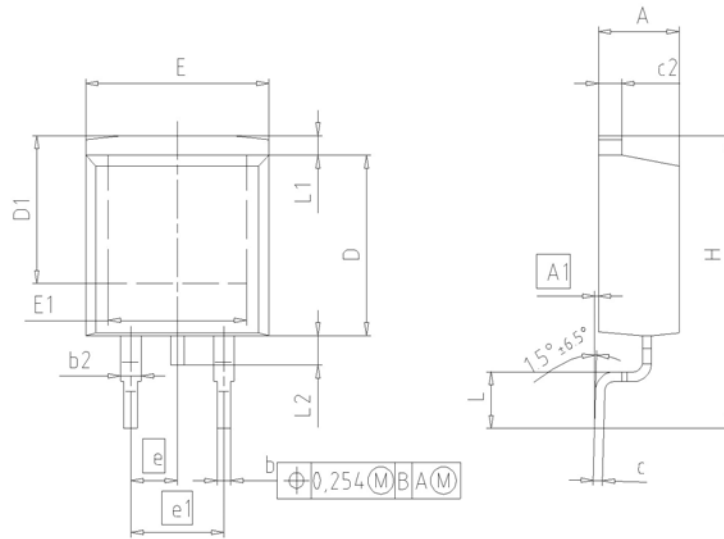
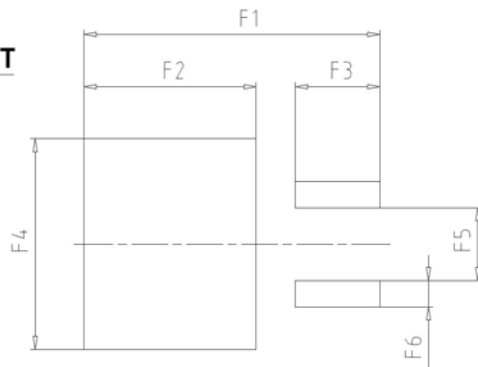
FOOTPRINT

DIM	MILLIMETERS		INCHES	
	MIN	MAX	MIN	MAX
A	4.30	4.57	0.169	0.180
A1	0.00	0.25	0.000	0.010
b	0.65	0.85	0.026	0.033
b2	0.95	1.15	0.037	0.045
c	0.33	0.65	0.013	0.026
c2	1.17	1.40	0.046	0.055
D	8.51	9.45	0.335	0.372
D1	7.10	7.90	0.280	0.311
E	9.80	10.31	0.386	0.406
E1	6.50	8.60	0.256	0.339
e	2.54		0.100	
e1	5.08		0.200	
N	2		2	
H	14.61	15.88	0.575	0.625
L	2.29	3.00	0.090	0.118
L1	0.70	1.60	0.028	0.063
L2	1.00	1.78	0.039	0.070
F1	16.05	16.25	0.632	0.640
F2	9.30	9.50	0.366	0.374
F3	4.50	4.70	0.177	0.185
F4	10.70	10.90	0.421	0.429
F5	3.65	3.85	0.144	0.152
F6	1.25	1.45	0.049	0.057

DOCUMENT NO.
Z8B00003324

SCALE

7.5mm

EUROPEAN PROJECTION

ISSUE DATE
30-08-2007

REVISION
01

Published by
Infineon Technologies AG
81726 Munich, Germany
© 2009 Infineon Technologies AG
All Rights Reserved.

Legal Disclaimer

The information given in this document shall in no event be regarded as a guarantee of conditions or characteristics. With respect to any examples or hints given herein, any typical values stated herein and/or any information regarding the application of the device, Infineon Technologies hereby disclaims any and all warranties and liabilities of any kind, including without limitation, warranties of non-infringement of intellectual property rights of any third party.

Information

For further information on technology, delivery terms and conditions and prices, please contact the nearest Infineon Technologies Office (www.infineon.com).

Warnings

Due to technical requirements, components may contain dangerous substances. For information on the types in question, please contact the nearest Infineon Technologies Office. Infineon Technologies components may be used in life-support devices or systems only with the express written approval of Infineon Technologies, if a failure of such components can reasonably be expected to cause the failure of that life-support device or system or to affect the safety or effectiveness of that device or system. Life support devices or systems are intended to be implanted in the human body or to support and/or maintain and sustain and/or protect human life. If they fail, it is reasonable to assume that the health of the user or other persons may be endangered.