

# Ultra Low Quiescent Current Linear Voltage Regulator

## TLS805B1

TLS805B1SJV

Linear Voltage Regulator

Data Sheet

Rev. 1.1, 2015-11-02

Automotive Power

**TLS805B1**

**TLS805B1SJV**



## 1 Overview

### Features

- Ultra Low Quiescent Current of 5  $\mu$ A
- Wide Input Voltage Range of 2.75 V to 42 V
- Output Current Capacity up to 50 mA
- Off Mode Current Less than 1  $\mu$ A
- Low Drop Out Voltage of typ. 100 mV @ 50 mA
- Output Current Limit Protection
- Overtemperature Shutdown
- Enable
- Available in PG-DSO-8 Package
- Wide Temperature Range
- Green Product (RoHS Compliant)
- AEC Qualified

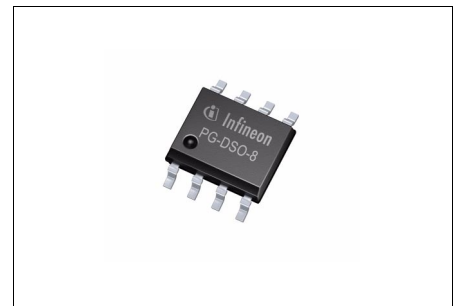

**Figure 1 PG-DSO-8**

Type	Package	Marking
TLS805B1SJV	PG-DSO-8	805B1V

---

**Overview**

**Description**

The TLS805B1 is a linear voltage regulator featuring wide input voltage range, low drop out voltage and ultra low quiescent current.

With an input voltage range of 2.75 V to 42 V and ultra low quiescent of only 5  $\mu$ A, the regulator is perfectly suitable for automotive or any other supply systems connected permanently to the battery.

The TLS805B1SJV is the adjustable output version with an accuracy of 2 % and output current capability up to 50 mA.

The new regulation concept implemented in TLS805B1 combines fast regulation and very good stability while requiring only a small ceramic capacitor of 1  $\mu$ F at the output.

The tracking region starts already at input voltages of 2.75 V (extended operating range). This makes the TLS805B1 also suitable to supply automotive systems that need to operate during cranking condition.

Internal protection features like output current limitation and overtemperature shutdown are implemented to protect the device against immediate damage due to failures like output short circuit to GND, over-current and over-temperature.

The device can be switched on and off by the Enable feature. When the device is switched off, the current consumption is typically less than 1  $\mu$ A.

**Choosing External Components**

An input capacitor  $C_I$  is recommended to compensate line influences. The output capacitor  $C_O$  is necessary for the stability of the regulating circuit. Stability is guaranteed at values  $C_O \geq 1 \mu$ F and an  $ESR \leq 100 \Omega$  within the whole operating range.

Block Diagram

## 2 Block Diagram

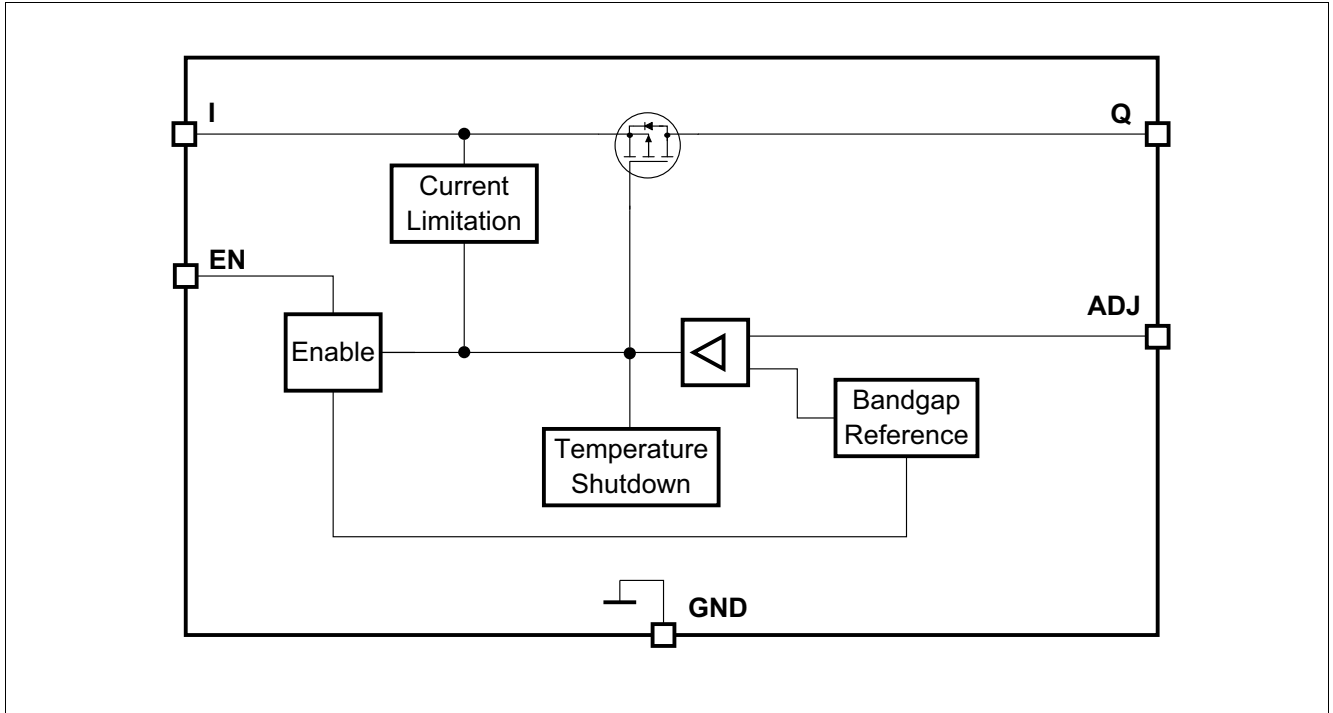

Figure 2 Block Diagram TLS805B1

Pin Configuration

### 3 Pin Configuration

#### 3.1 Pin Assignment in PG-DSO-8 Package

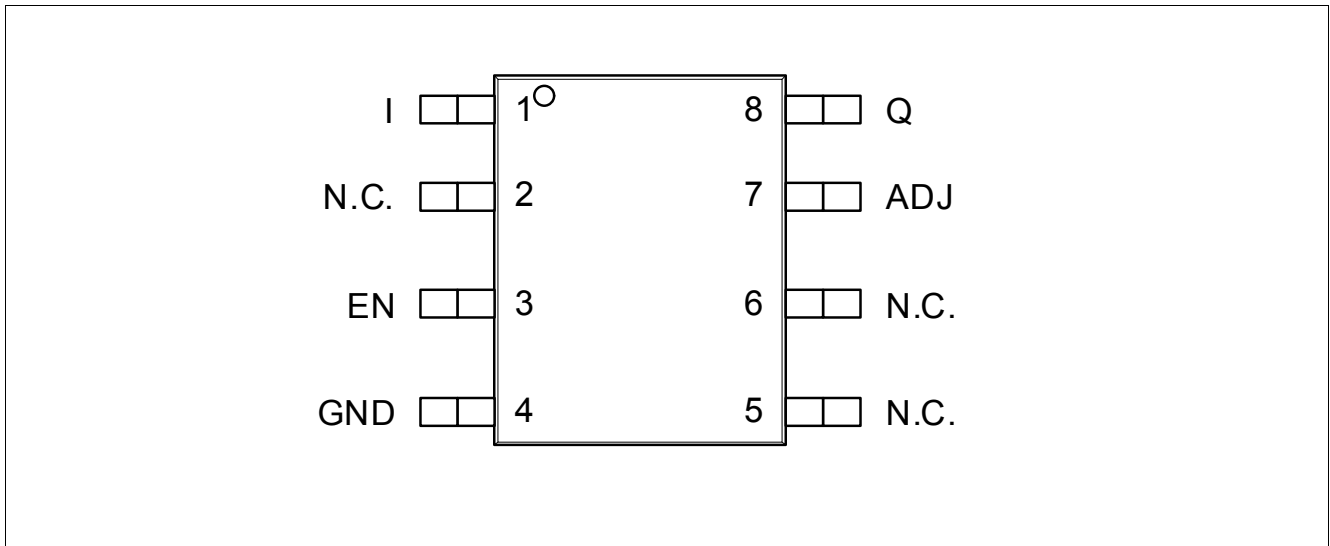

Figure 3 Pin Configuration TLS805B1 in PG-DSO-8 package

#### 3.2 Pin Definitions and Functions in PG-DSO-8 Package

Pin	Symbol	Function
1	I	<b>Input</b> It is recommended to place a small ceramic capacitor (e.g. 100 nF) to GND, close to the IC terminals, in order to compensate line influences.
2	N.C.	<b>Not connected</b>
3	EN	<b>Enable</b> Integrated pull-down resistor. Enable the IC with high level input signal. Disable the IC with low level input signal.
4	GND	<b>Ground</b>
5	N.C.	<b>Not connected</b>
6	N.C.	<b>Not connected</b>
7	ADJ	<b>Voltage Adjustment</b> Connect an external voltage divider to determine the output voltage.
8	Q	<b>Output</b> Connect an output capacitor $C_Q$ to GND close to the IC's terminals, respecting the values specified for its capacitance and ESR in <a href="#">Table 2 "Functional Range" on Page 7</a> .

General Product Characteristics

## 4 General Product Characteristics

### 4.1 Absolute Maximum Ratings

**Table 1 Absolute Maximum Ratings<sup>1)</sup>**

$T_j = -40\text{ °C}$  to  $+150\text{ °C}$ ; all voltages with respect to ground (unless otherwise specified)

Parameter	Symbol	Values			Unit	Note or Test Condition	Number
		Min.	Typ.	Max.			
<b>Voltage Input I, Enable EN</b>							
Voltage	$V_I, V_{EN}$	-0.3	-	45	V	-	P_4.1.1
<b>Voltage Output Q</b>							
Voltage	$V_Q$	-0.3	-	45	V	-	P_4.1.2
<b>Voltage Adjustment ADJ</b>							
Voltage	$V_{ADJ}$	-0.3	-	7	V	-	P_4.1.3
<b>Temperatures</b>							
Junction Temperature	$T_j$	-40	-	150	°C	-	P_4.1.4
Storage Temperature	$T_{stg}$	-55	-	150	°C	-	P_4.1.5
<b>ESD Absorption</b>							
ESD Susceptibility to GND	$V_{ESD,HBM}$	-2	-	2	kV	HBM <sup>2)</sup>	P_4.1.6
ESD Susceptibility to GND	$V_{ESD,CDM}$	-750	-	750	V	CDM <sup>3)</sup> at all pins	P_4.1.7

1) Not subject to production testing, specified by design.

2) ESD susceptibility, HBM according to ANSI/ESDA/JEDEC JS001 (1.5 kΩ, 100 pF)

3) ESD susceptibility, Charged Device Model “CDM” according JEDEC JESD22-C101

#### Notes

1. Stresses above the ones listed here may cause permanent damage to the device. Exposure to absolute maximum rating conditions for extended periods may affect device reliability.
2. Integrated protection functions are designed to prevent IC destruction under fault conditions described in the data sheet. Fault conditions are considered as “outside” normal operating range. Protection functions are not designed for continuous repetitive operation.

General Product Characteristics

4.2 Functional Range

Table 2 Functional Range

Parameter	Symbol	Values			Unit	Note or Test Condition	Number
		Min.	Typ.	Max.			
Input Voltage Range	$V_I$	$V_{Q,nom} + V_{dr}$	-	42	V	- <sup>1)</sup>	P_4.2.1
Extended Input Voltage Range	$V_{I,ext}$	2.75	-	42	V	- <sup>2)</sup>	P_4.2.2
Output Capacitor	$C_Q$	1	-	-	$\mu F$	- <sup>3)4)</sup>	P_4.2.3
Output Capacitor's ESR	$ESR(C_Q)$	-	-	100	$\Omega$	- <sup>4)</sup>	P_4.2.4
Junction temperature	$T_j$	-40	-	150	$^{\circ}C$	-	P_4.2.5

- 1) Output current is limited internally and depends on the input voltage, see Electrical Characteristics for more details.
- 2) When  $V_I$  is between  $V_{I,ext,min}$  and  $V_{Q,nom} + V_{dr}$ ,  $V_Q = V_I - V_{dr}$ . When  $V_I$  is below  $V_{I,ext,min}$ ,  $V_Q$  can drop down to 0 V.
- 3) The minimum output capacitance requirement is applicable for a worst case capacitance tolerance of 30%.
- 4) Not subject to production testing, specified by design.

Note: Within the functional or operating range, the IC operates as described in the circuit description. The electrical characteristics are specified within the conditions given in the Electrical Characteristics table.

**General Product Characteristics**

**4.3 Thermal Resistance**

Note: This thermal data was generated in accordance with JEDEC JESD51 standards. For more information, go to [www.jedec.org](http://www.jedec.org).

**Table 3 Thermal Resistance TLS805B1 in PG-DSO-8 Package**

Parameter	Symbol	Values			Unit	Note or Test Condition	Number
		Min.	Typ.	Max.			
<b>Package Version PG-DSO-8</b>							
Junction to Case <sup>1)</sup>	$R_{thJC}$	–	40	–	K/W	–	P_4.3.1
Junction to Ambient	$R_{thJA}$	–	114	–	K/W	2s2p board <sup>2)</sup>	P_4.3.2
Junction to Ambient	$R_{thJA}$	–	172	–	K/W	1s0p board, footprint only <sup>3)</sup>	P_4.3.3
Junction to Ambient	$R_{thJA}$	–	139	–	K/W	1s0p board, 300 mm <sup>2</sup> heatsink area on PCB <sup>3)</sup>	P_4.3.4
Junction to Ambient	$R_{thJA}$	–	133	–	K/W	1s0p board, 600 mm <sup>2</sup> heatsink area on PCB <sup>3)</sup>	P_4.3.5

- 1) Not subject to production test, specified by design
- 2) Specified  $R_{thJA}$  value is according to Jecdec JESD51-2,-5,-7 at natural convection on FR4 2s2p board; The Product (Chip+Package) was simulated on a 76.2 x 114.3 x 1.5 mm<sup>3</sup> board with 2 inner copper layers (2 x 70µm Cu, 2 x 35µm Cu). Where applicable a thermal via array under the exposed pad contacted the first inner copper layer.
- 3) Specified  $R_{thJA}$  value is according to JEDEC JESD 51-3 at natural convection on FR4 1s0p board; The Product (Chip+Package) was simulated on a 76.2 x 114.3 x 1.5 mm<sup>3</sup> board with 1 copper layer (1 x 70µm Cu).



Block Description and Electrical Characteristics

## 5 Block Description and Electrical Characteristics

### 5.1 Voltage Regulation

The output voltage  $V_Q$  is divided by a resistor network. This fractional voltage is compared to an internal voltage reference and the pass transistor is driven accordingly.

The control loop stability depends on the output capacitor  $C_Q$ , the load current, the chip temperature and the internal circuit structure. To ensure stable operation, the output capacitor's capacitance and its equivalent series resistor ESR requirements given in "Functional Range" on Page 7 have to be maintained. For details see the typical performance graph **Output Capacitor Series Resistor ESR( $C_Q$ ) versus Output Current  $I_Q$** . Since the output capacitor is used to buffer load steps, it should be sized according to the application's needs.

An input capacitor  $C_I$  is not required for stability, but is recommended to compensate line fluctuations. An additional reverse polarity protection diode and a combination of several capacitors for filtering should be used, in case the input is connected directly to the battery line. Connect the capacitors close to the regulator terminals.

In order to prevent overshoots during start-up, a smooth ramping up function is implemented. This ensures almost no overshoots during start-up, mostly independent from load and output capacitance.

Whenever the load current exceeds the specified limit, e.g. in case of a short circuit, the output current is limited and the output voltage decreases.

The overtemperature shutdown circuit prevents the IC from immediate destruction under fault conditions (e.g. output continuously short-circuit) by switching off the power stage. After the chip has cooled down, the regulator restarts. This oscillatory thermal behaviour causes the junction temperature to exceed the maximum rating of 150°C and can significantly reduce the IC's lifetime.

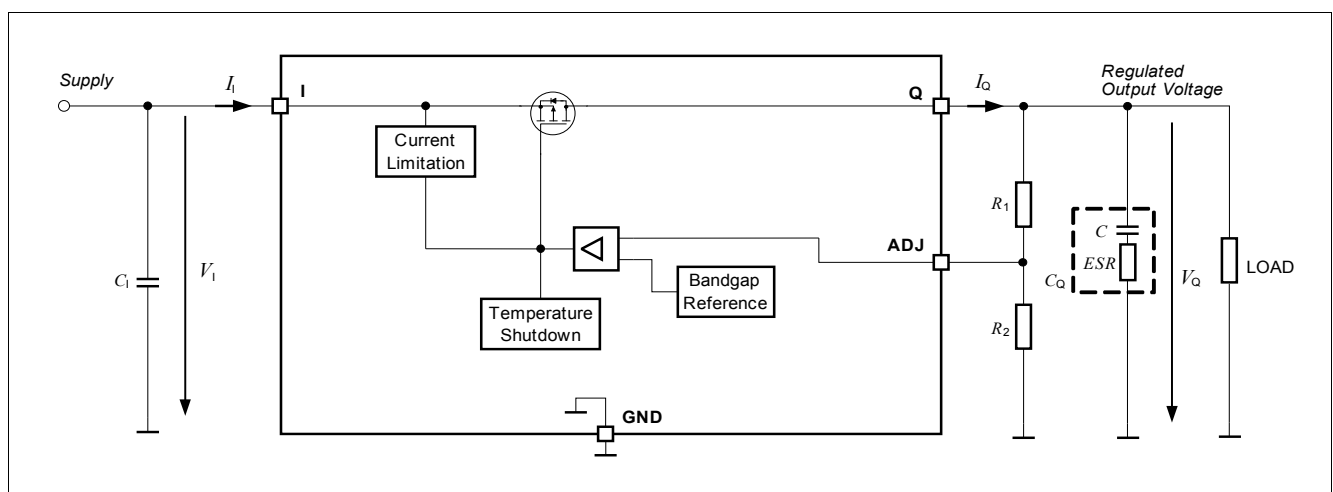

Figure 4 Block Diagram Voltage Regulation

**Block Description and Electrical Characteristics**

**Table 4 Electrical Characteristics**

$T_j = -40\text{ °C}$  to  $+150\text{ °C}$ ,  $V_I = 13.5\text{ V}$ , all voltages with respect to ground (unless otherwise specified).

Typical values are given at  $T_j = 25\text{ °C}$ ,  $V_I = 13.5\text{ V}$ .

Parameter	Symbol	Values			Unit	Note or Test Condition	Number
		Min.	Typ.	Max.			
Output Voltage Precision <sup>1)</sup>	$\Delta V_Q$	-2	-	2	%	$50\text{ }\mu\text{A} \leq I_Q \leq 50\text{ mA}$ , $V_Q + V_{dr} \leq V_I \leq 28\text{ V}$ , $V_I \geq 3\text{ V}$ , $R_2 \leq 250\text{ k}\Omega$	P_5.1.1
Output Voltage Precision	$\Delta V_Q$	-2	-	2	%	$50\text{ }\mu\text{A} \leq I_Q \leq 25\text{ mA}$ , $V_Q + V_{dr} \leq V_I \leq 42\text{ V}$ , $V_I \geq 3\text{ V}$ , $R_2 \leq 250\text{ k}\Omega$	P_5.1.2
Output Current Limitation	$I_{Q,lim}$	51	85	120	mA	$0\text{ V} \leq V_Q \leq V_{Q,nom} - 0.1\text{ V}$	P_5.1.3
Line Regulation steady-state	$\Delta V_{Q,line}$	-	1	20	mV	$I_Q = 1\text{ mA}$ , $6\text{ V} \leq V_I \leq 32\text{ V}$	P_5.1.4
Load Regulation steady-state	$\Delta V_{Q,load}$	-20	-1	-	mV	$V_I = 6\text{ V}$ , $50\text{ }\mu\text{A} \leq I_Q \leq 50\text{ mA}$	P_5.1.5
Dropout Voltage <sup>2)</sup> $V_{dr} = V_I - V_Q$	$V_{dr}$	-	100	300	mV	$I_Q = 50\text{ mA}$ , $V_I = 5.4\text{ V}$	P_5.1.6
Reference voltage	$V_{ref}$	1.17	1.2	1.23	V	-	P_5.1.7
Output Voltage Adjustable Range	$V_{Q,Range}$	1.2	-	$V_I - V_{dr}$	V	$V_I < 42\text{ V}$	P_5.1.8
Ripple Rejection <sup>3)</sup>	$PSRR$	-	60	-	dB	$I_Q = 50\text{ mA}$ , $V_Q = 1.2\text{ V}$ , $f_{ripple} = 100\text{ Hz}$ , $V_{ripple} = 0.5\text{ V}_{p-p}$	P_5.1.9
Overtemperature Shutdown Threshold	$T_{j,sd}$	151	175	-	°C	$T_j$ increasing	P_5.1.10
Overtemperature Shutdown Threshold Hysteresis	$T_{j,sdh}$	-	10	-	K	$T_j$ decreasing	P_5.1.11

1) Referring to the device tolerance only, the tolerance of the resistor divider can cause additional deviation. Parameter is tested with the ADJ pin directly connected to the output pin Q.

2) Measured when the output voltage  $V_Q$  has dropped 100 mV from the nominal value obtained at  $V_I = 13.5\text{ V}$

3) Not subject to production test, specified by design

Block Description and Electrical Characteristics

5.2 Typical Performance Characteristics Voltage Regulation

Typical Performance Characteristics

Output Voltage  $V_Q$  versus Junction Temperature  $T_j$

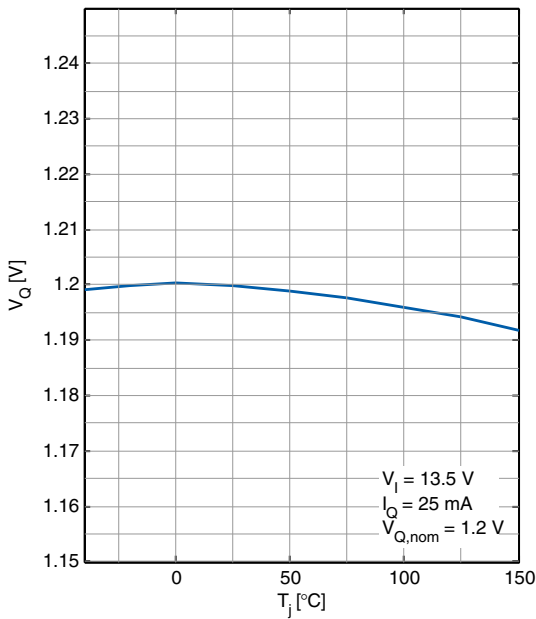

Output Current  $I_Q$  versus Input Voltage  $V_I$

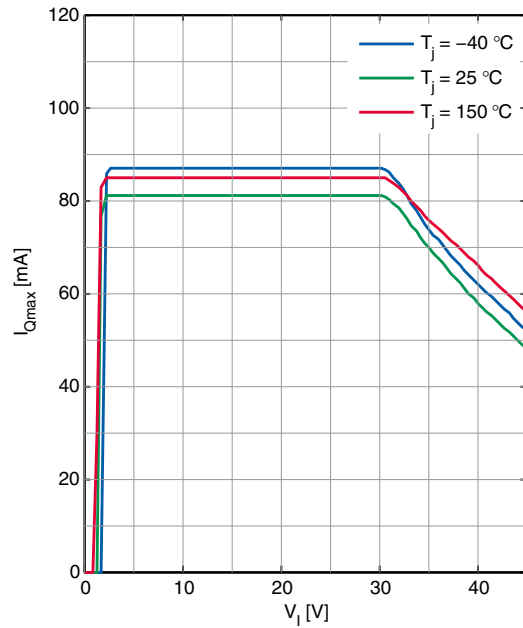

Dropout Voltage  $V_{dr}$  versus Junction Temperature  $T_j$

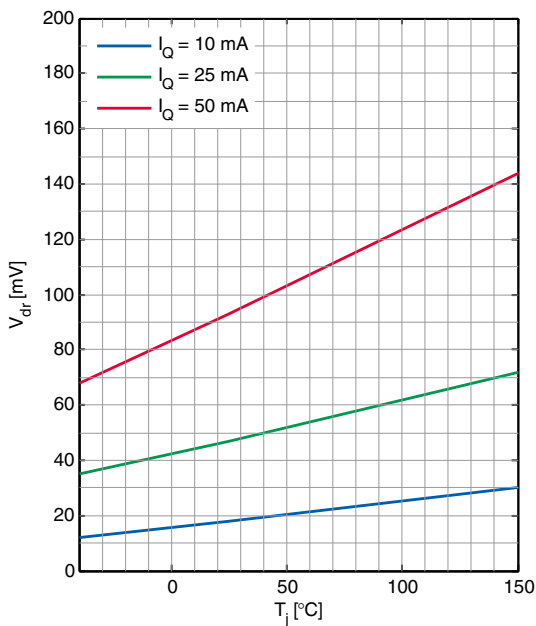

Dropout Voltage  $V_{dr}$  versus Output Current  $I_Q$

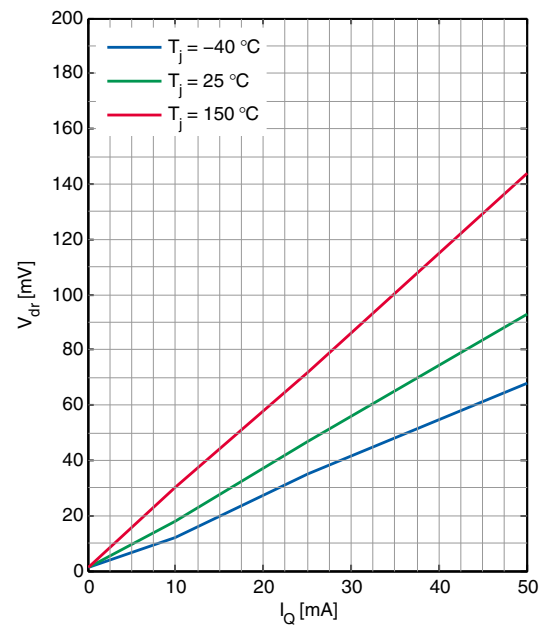

Block Description and Electrical Characteristics

Load Regulation  $\Delta V_{Q,load}$  versus Output Current  $I_Q$

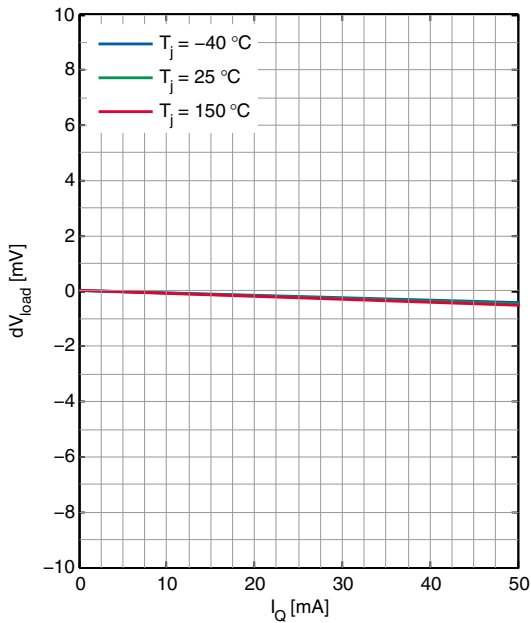

Line Regulation  $\Delta V_{Q,line}$  versus Input Voltage  $V_I$

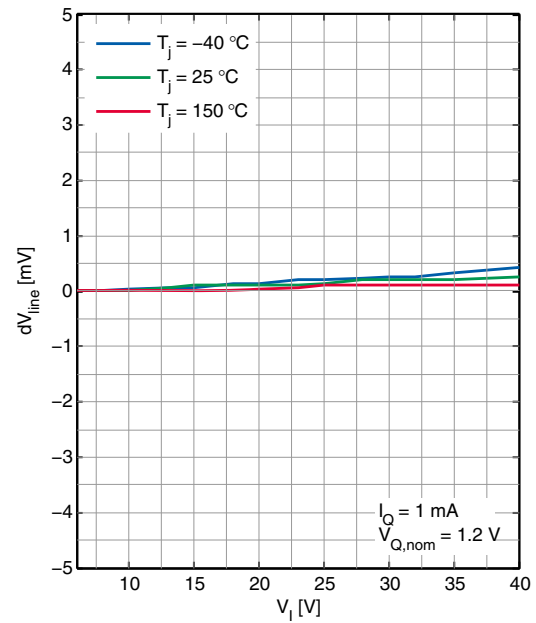

Output Voltage  $V_Q$  versus Input Voltage  $V_I$

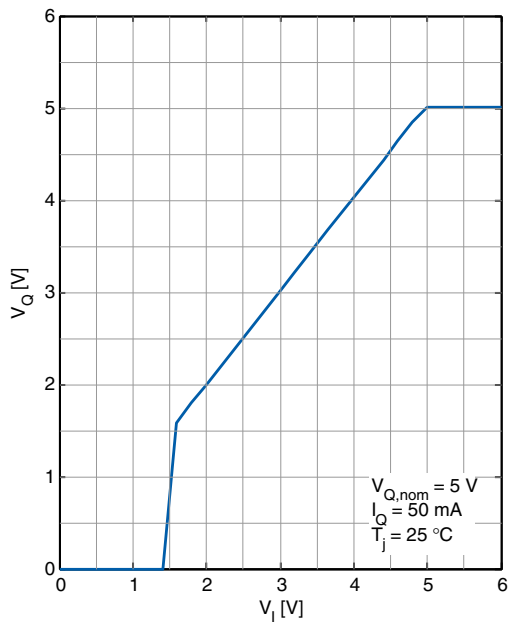

Power Supply Ripple Rejection  $PSRR$  versus Ripple Frequency  $f_r$

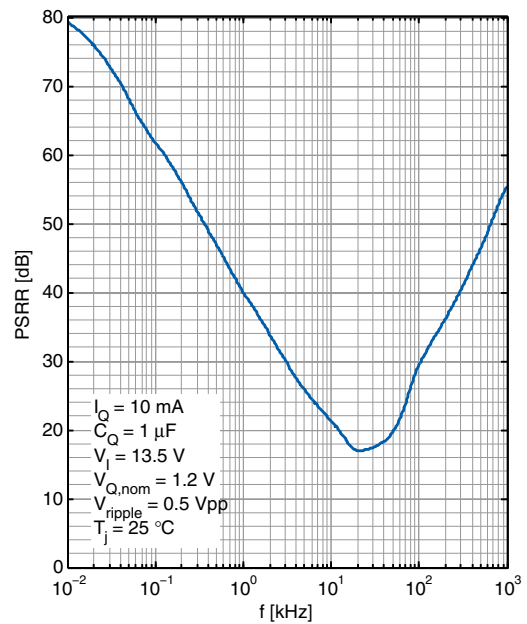

Block Description and Electrical Characteristics

Output Capacitor Series Resistor  $ESR(C_Q)$  versus Output Current  $I_Q$

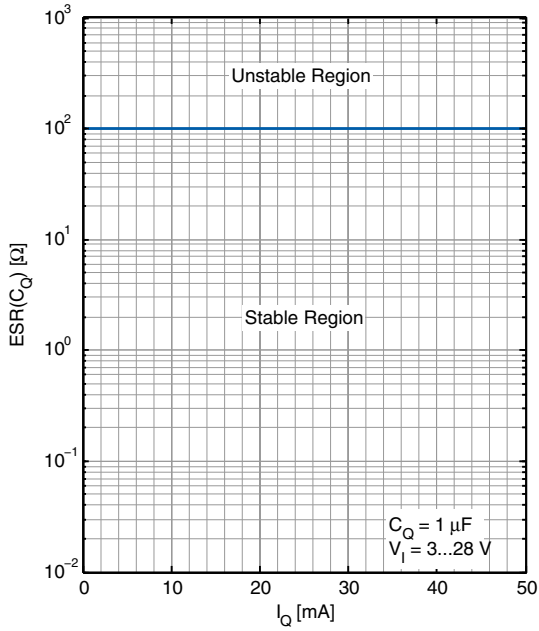

Block Description and Electrical Characteristics

5.3 Current Consumption

**Table 5 Electrical Characteristics Current Consumption**

$T_j = -40\text{ °C}$  to  $+150\text{ °C}$ ,  $V_I = 13.5\text{ V}$  (unless otherwise specified).

Parameter	Symbol	Values			Unit	Note or Test Condition	Number
		Min.	Typ.	Max.			
Current Consumption $I_q = I_I$	$I_{q,off}$	–	–	1	$\mu\text{A}$	$V_{EN} \leq 0.4\text{ V}$ , $T_j < 105\text{ °C}$	P_5.3.1
Current Consumption $I_q = I_I - I_Q$	$I_q$	–	5	7.5	$\mu\text{A}$	$I_Q = 50\ \mu\text{A}$ , $T_j = 25\text{ °C}$	P_5.3.2
Current Consumption $I_q = I_I - I_Q$	$I_q$	–	6	10	$\mu\text{A}$	$I_Q = 50\ \mu\text{A}$ , $T_j < 105\text{ °C}$	P_5.3.3
Current Consumption $I_q = I_I - I_Q$	$I_q$	–	6.5	11	$\mu\text{A}$	$I_Q = 50\ \mu\text{A}$ , $T_j < 125\text{ °C}$	P_5.3.4
Current Consumption $I_q = I_I - I_Q$	$I_q$	–	6.5	11	$\mu\text{A}$	$I_Q = 50\ \text{mA}$ , $T_j < 125\text{ °C}$	P_5.3.5

Block Description and Electrical Characteristics

5.4 Typical Performance Characteristics Current Consumption

Typical Performance Characteristics

Current Consumption  $I_q$  versus Output Current  $I_Q$

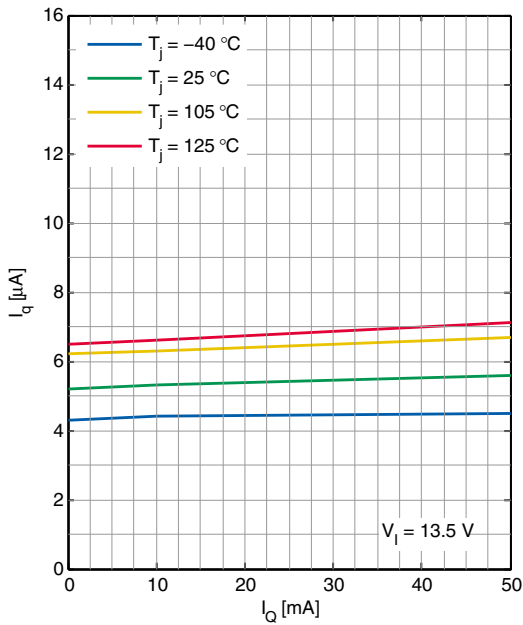

Current Consumption  $I_q$  versus Input Voltage  $V_1$

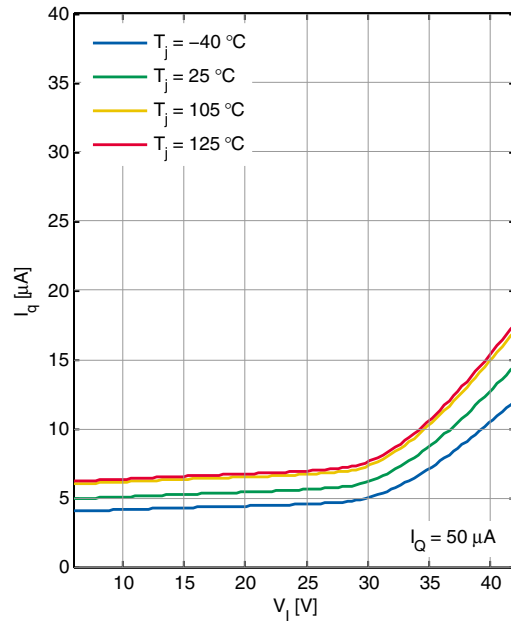

Current Consumption  $I_q$  versus Junction Temperature  $T_j$

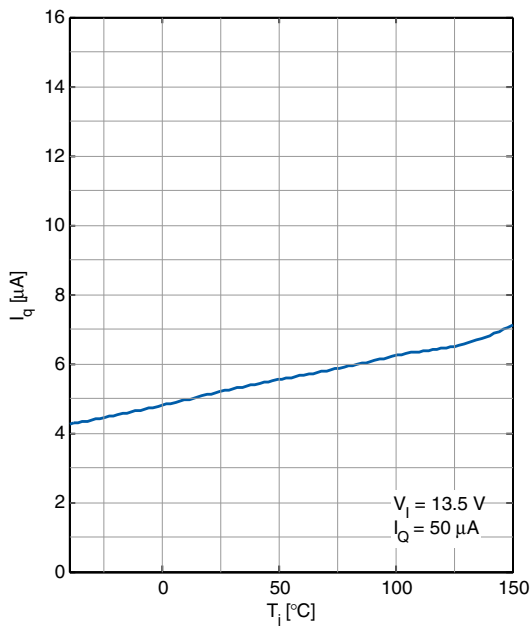

Current Consumption in OFF mode  $I_{q,off}$  versus Junction Temperature  $T_j$

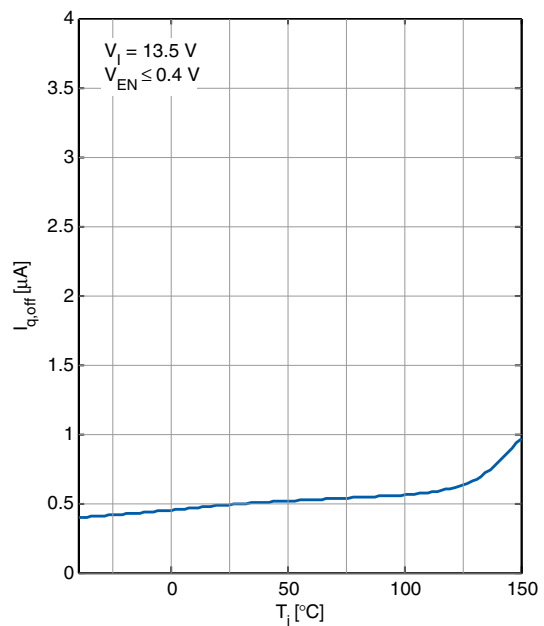

**Block Description and Electrical Characteristics**

**5.5 Enable**

The device can be switched on and off by the Enable feature. Connect a HIGH level as specified below (e.g. the battery voltage) to pin EN to enable the device; connect a LOW level as specified below (e.g. GND) to switch it off. The Enable function has a build-in hysteresis to avoid toggling between ON/OFF state, if signals with slow slopes are applied to the EN input.

**Table 6 Electrical Characteristics Enable**

$T_j = -40\text{ °C}$  to  $+150\text{ °C}$ ,  $V_I = 13.5\text{ V}$ , all voltages with respect to ground (unless otherwise specified). Typical values are given at  $T_j = 25\text{ °C}$ ,  $V_I = 13.5\text{ V}$ .

Parameter	Symbol	Values			Unit	Note or Test Condition	Number
		Min.	Typ.	Max.			
Enable High Level Input Voltage	$V_{EN,H}$	2	–	–	V	$V_Q$ settled	P_5.5.1
Enable Low Level Input Voltage	$V_{EN,L}$	–	–	0.8	V	$V_Q \leq 0.1\text{ V}$	P_5.5.2
Enable High Level Input Current	$I_{EN,H}$	–	–	4	$\mu\text{A}$	$V_{EN} = 5\text{ V}$	P_5.5.3
Enable Internal Pull-down Resistor	$R_{EN}$	1.25	2	3.5	$\text{M}\Omega$	–	P_5.5.4



Block Description and Electrical Characteristics

5.6 Typical Performance Characteristics Enable

Typical Performance Characteristics

Enable Input Current  $I_{EN}$  versus  
Enable Input Voltage  $V_{EN}$

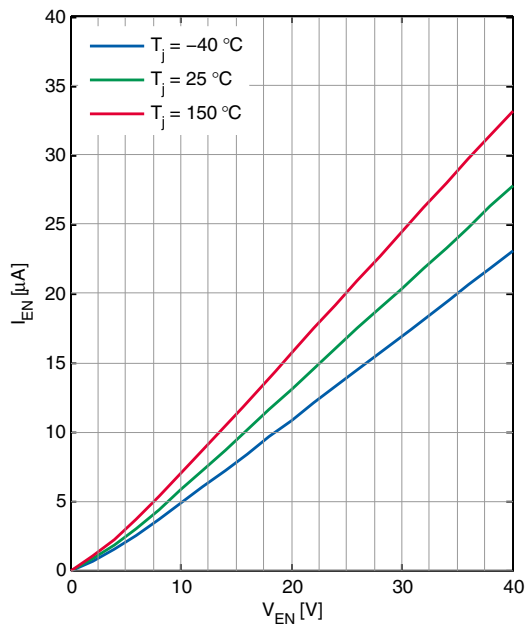

Application Information

## 6 Application Information

Note: The following information is given as a hint for the implementation of the device only and shall not be regarded as a description or warranty of a certain functionality, condition or quality of the device.

### 6.1 Application Diagram

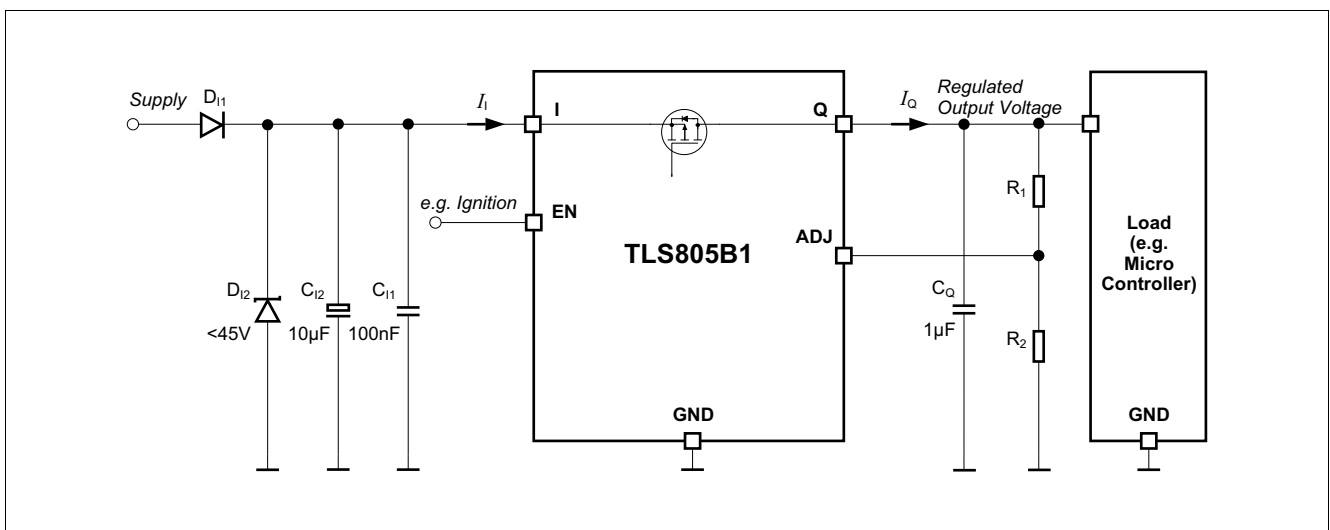

Figure 5 Application Diagram

### 6.2 Selection of External Components

#### 6.2.1 Input Pin

The typical input circuitry for a linear voltage regulator is shown in the application diagram above.

A ceramic capacitor at the input, in the range of 100 nF to 470 nF, is recommended to filter out the high frequency disturbances imposed by the line e.g. ISO pulses 3a/b. This capacitor must be placed very close to the input pin of the linear voltage regulator on the PCB.

An aluminum electrolytic capacitor in the range of 10 µF to 470 µF is recommended as an input buffer to smooth out high energy pulses, such as ISO pulse 2a. This capacitor should be placed close to the input pin of the linear voltage regulator on the PCB.

An overvoltage suppressor diode can be used to further suppress any high voltage beyond the maximum rating of the linear voltage regulator and protect the device against any damage due to over-voltage.

The external components at the input are not mandatory for the operation of the voltage regulator, but they are recommended in case of possible external disturbances.

**Application Information**

**6.2.2 Output Pin**

An output capacitor is mandatory for the stability of linear voltage regulators.

The requirement to the output capacitor is given in **“Functional Range” on Page 7**. The graph **“Output Capacitor Series Resistor ESR(C<sub>Q</sub>) versus Output Current I<sub>Q</sub>” on Page 13** shows the stable operation range of the device.

TLS805B1 is designed to be stable with extremely low ESR capacitors. According to the automotive environment, ceramic capacitors with X5R or X7R dielectrics are recommended.

The output capacitor should be placed as close as possible to the regulator’s output and GND pins and on the same side of the PCB as the regulator itself.

In case of rapid transients of input voltage or load current, the capacitance should be dimensioned in accordance and verified in the real application that the output stability requirements are fulfilled.

**6.3 Output Voltage Adjust**

The output voltage of TLS805B1SJV can be adjusted between 1.2 V and  $V_I - V_{dr}$  by an external resistor divider, connected to the adjust pin ADJ, as shown in **Figure 5**.

The pin ADJ is connected to the error amplifier comparing the voltage at this pin with the internal reference voltage of typically 1.2 V.

The output voltage can be easily calculated, neglecting the current flowing into the ADJ pin:

$$V_Q = \frac{R_1 + R_2}{R_2} \times V_{ref} \tag{6.1}$$

with

- $V_{ref}$ : internal reference voltage, typically 1.2V
- $R_1$ : resistor between regulator output Q and adjust pin ADJ
- $R_2$ : resistor between adjust pin ADJ and GND

The bigger the resistors  $R_1$  and  $R_2$ , the less the current flowing through the resistor divider. However, using too big resistors makes the current flowing into the ADJ pin non-negligible. In order to neglect the current flowing into the ADJ pin, the values of  $R_1$  and  $R_2$  should be selected fulfilling the criteria  $R_2 \leq 250 \text{ k}\Omega$ .

To set the output voltage to 1.2 V, the adjust pin ADJ should be directly connected to the output pin Q.

Take into consideration that an additional error to the output voltage tolerance may be introduced by the accuracy of the resistors  $R_1$  and  $R_2$ .

**6.4 Thermal Considerations**

Knowing the input voltage, the output voltage and the load profile of the application, the total power dissipation can be calculated:

$$P_D = (V_I - V_Q) \times I_Q + V_I \times I_q \tag{6.2}$$

with

- $P_D$ : continuous power dissipation
- $V_I$ : input voltage
- $V_Q$ : output voltage

## Application Information

- $I_Q$ : output current
- $I_q$ : quiescent current

The maximum acceptable thermal resistance  $R_{thJA}$  can then be calculated:

$$R_{thJA, \max} = \frac{T_{j, \max} - T_a}{P_D} \quad (6.3)$$

with

- $T_{j, \max}$ : maximum allowed junction temperature
- $T_a$ : ambient temperature

Based on the above calculation the proper PCB type and the necessary heat sink area can be determined with reference to the specification in **“Thermal Resistance” on Page 8**.

### Example

Application conditions:

$$V_I = 13.5 \text{ V}$$

$$V_Q = 5 \text{ V}$$

$$I_Q = 35 \text{ mA}$$

$$T_a = 105 \text{ °C}$$

Calculation of  $R_{thJA, \max}$ :

$$\begin{aligned} P_D &= (V_I - V_Q) \times I_Q + V_I \times I_q \\ &= (13.5\text{V} - 5\text{V}) \times 35 \text{ mA} + 13.5 \text{ V} \times 0.0115 \text{ mA} \\ &= 0.2975 \text{ W} \end{aligned}$$

$$\begin{aligned} R_{thJA, \max} &= (T_{j, \max} - T_a) / P_D \\ &= (150 \text{ °C} - 105 \text{ °C}) / 0.2975 \text{ W} \\ &= 151.2 \text{ K/W} \end{aligned}$$

As a result, the PCB design must ensure a thermal resistance  $R_{thJA}$  lower than 151.2 K/W. According to **“Thermal Resistance” on Page 8**, at least 300 mm<sup>2</sup> heatsink area is needed on the FR4 1s0p PCB, or the FR4 2s2p board can be used.

## 6.5 Reverse Polarity Protection

TLS805B1 is not self protected against reverse polarity faults. To protect the device against negative supply voltage, an external reverse polarity diode is needed, as shown in **Figure 5**. The absolute maximum ratings of the device as specified in **“Absolute Maximum Ratings” on Page 6** must be kept.

## 6.6 Further Application Information

- For further information you may contact <http://www.infineon.com/>

Package Outlines

7 Package Outlines

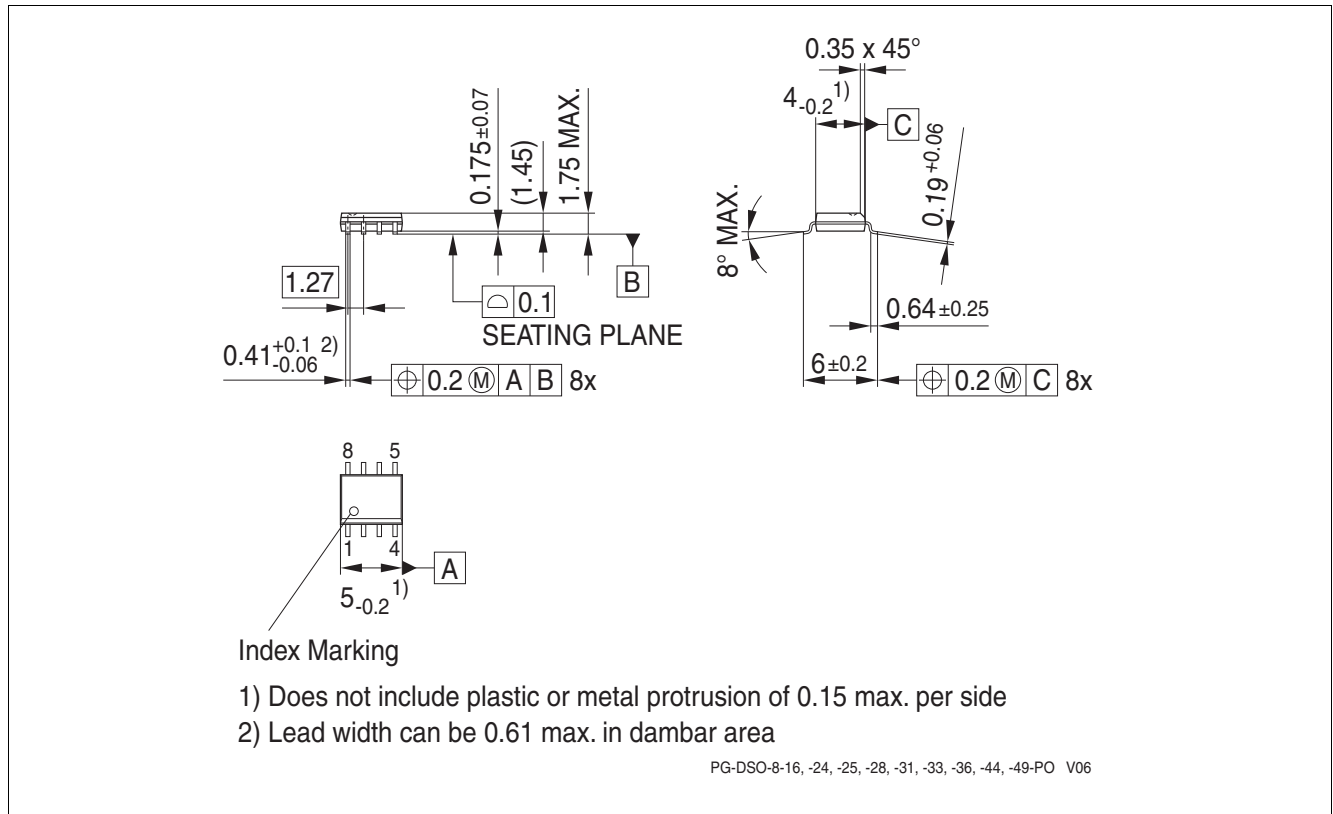

Figure 6 PG-DSO-8

Green Product (RoHS compliant)

To meet the world-wide customer requirements for environmentally friendly products and to be compliant with government regulations the device is available as a green product. Green products are RoHS-Compliant (i.e Pb-free finish on leads and suitable for Pb-free soldering according to IPC/JEDEC J-STD-020).

---

**Revision History**

**8 Revision History**

<b>Revision</b>	<b>Date</b>	<b>Changes</b>
1.1	2015-11-02	<ul style="list-style-type: none"> <li>- Functional range of the Enable input voltage defined.</li> <li>- Document style updated.</li> <li>- Typical performance graph Load Regulation updated.</li> <li>- Editorial changes.</li> </ul>
1.0	2015-02-05	Datasheet - Initial Version

#### Trademarks of Infineon Technologies AG

AURIX™, C166™, CanPAK™, CIPOS™, CIPURSE™, CoolMOS™, CoolSET™, CORECONTROL™, CROSSAVE™, DAVE™, DI-POL™, EasyPIM™, EconoBRIDGE™, EconoDUAL™, EconoPIM™, EconoPACK™, EiceDRIVER™, eupec™, FCOS™, HITFET™, HybridPACK™, I<sup>2</sup>RF™, ISOFACE™, IsoPACK™, LITIX™, MIPAQ™, ModSTACK™, my-d™, NovalithIC™, OptiMOS™, ORIGA™, POWERCODE™, PRIMARION™, PrimePACK™, PrimeSTACK™, PRO-SIL™, PROFET™, RASIC™, ReverSave™, SatRIC™, SIEGET™, SINDRION™, SIPMOS™, SmartLEWIS™, SPOC™, SOLID FLASH™, TEMPFET™, thinQ™, TRENCHSTOP™, TriCore™.

#### Other Trademarks

Advance Design System™ (ADS) of Agilent Technologies, AMBA™, ARM™, MULTI-ICE™, KEIL™, PRIMECELL™, REALVIEW™, THUMB™, μVision™ of ARM Limited, UK. AUTOSAR™ is licensed by AUTOSAR development partnership. Bluetooth™ of Bluetooth SIG Inc. CAT-iq™ of DECT Forum. COLOSSUS™, FirstGPS™ of Trimble Navigation Ltd. EMV™ of EMVCo, LLC (Visa Holdings Inc.). EPCOS™ of Epcos AG. FLEXGO™ of Microsoft Corporation. FlexRay™ is licensed by FlexRay Consortium. HYPERTERMINAL™ of Hilgraeve Incorporated. IEC™ of Commission Electrotechnique Internationale. IrDA™ of Infrared Data Association Corporation. ISO™ of INTERNATIONAL ORGANIZATION FOR STANDARDIZATION. MATLAB™ of MathWorks, Inc. MAXIM™ of Maxim Integrated Products, Inc. MICROTEC™, NUCLEUS™ of Mentor Graphics Corporation. MIPI™ of MIPI Alliance, Inc. MIPS™ of MIPS Technologies, Inc., USA. muRata™ of MURATA MANUFACTURING CO., MICROWAVE OFFICE™ (MWO) of Applied Wave Research Inc., OmniVision™ of OmniVision Technologies, Inc. Openwave™ Openwave Systems Inc. RED HAT™ Red Hat, Inc. RFMD™ RF Micro Devices, Inc. SIRIUS™ of Sirius Satellite Radio Inc. SOLARIS™ of Sun Microsystems, Inc. SPANSION™ of Spansion LLC Ltd. Symbian™ of Symbian Software Limited. TAIYO YUDEN™ of Taiyo Yuden Co. TEAKLITE™ of CEVA, Inc. TEKTRONIX™ of Tektronix Inc. TOKO™ of TOKO KABUSHIKI KAISHA TA. UNIX™ of X/Open Company Limited. VERILOG™, PALLADIUM™ of Cadence Design Systems, Inc. VLYNQ™ of Texas Instruments Incorporated. VXWORKS™, WIND RIVER™ of WIND RIVER SYSTEMS, INC. ZETEX™ of Diodes Zetex Limited.

Last Trademarks Update 2011-11-11

[www.infineon.com](http://www.infineon.com)

**Edition 2015-11-02**

**Published by**

**Infineon Technologies AG**

**81726 Munich, Germany**

**© 2015 Infineon Technologies AG.**

**All Rights Reserved.**

**Do you have a question about any aspect of this document?**

**Email: [erratum@infineon.com](mailto:erratum@infineon.com)**

#### Legal Disclaimer

The information given in this document shall in no event be regarded as a guarantee of conditions or characteristics. With respect to any examples or hints given herein, any typical values stated herein and/or any information regarding the application of the device, Infineon Technologies hereby disclaims any and all warranties and liabilities of any kind, including without limitation, warranties of non-infringement of intellectual property rights of any third party.

#### Information

For further information on technology, delivery terms and conditions and prices, please contact the nearest Infineon Technologies Office ([www.infineon.com](http://www.infineon.com)).

#### Warnings

Due to technical requirements, components may contain dangerous substances. For information on the types in question, please contact the nearest Infineon Technologies Office. Infineon Technologies components may be used in life-support devices or systems only with the express written approval of Infineon Technologies, if a failure of such components can reasonably be expected to cause the failure of that life-support device or system or to affect the safety or effectiveness of that device or system. Life support devices or systems are intended to be implanted in the human body or to support and/or maintain and sustain and/or protect human life. If they fail, it is reasonable to assume that the health of the user or other persons may be endangered.