

TND323VD



Excellent Power Device Inverter and buffer driver for general purpose

ON Semiconductor®

www.onsemi.com

Features

- Inverter buffer
- Monolithic structure (High voltage CMOS process adopted)
- Withstand voltage of 25V is assured
- Wide range of operating voltage : 4.5V to 25V
- Peak output current : $I_{O+}/I_{O-} = 0.8A / 1A$
- Fast switching time (30ns typical at 1000pF load)
- Fully compatible input to TTL / CMOS ($V_{IH} = \text{up to } 2.6V$, at $V_{DD} = 4.5$ to 25V)
- Built-in input pull-down resistance

Specifications

Absolute Maximum Ratings at $T_a = 25^\circ\text{C}$

Parameter	Symbol	Conditions	Ratings	Unit
Supply Voltage	V_{DD}		0 to 25	V
Input Voltage	V_{IN}		$GND - 0.3$ to $V_{DD} + 0.3$	V
Allowable Power Dissipation	$P_D \text{ max}$		0.2	W
Junction Temperature	T_j		-55 to +150	$^\circ\text{C}$
Storage Temperature	T_{stg}		-55 to +150	$^\circ\text{C}$

Stresses exceeding those listed in the Maximum Ratings table may damage the device. If any of these limits are exceeded, device functionality should not be assumed, damage may occur and reliability may be affected.

Packing Type : TL

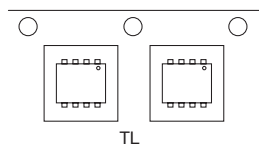

Marking

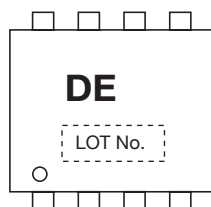

Pin Assignment

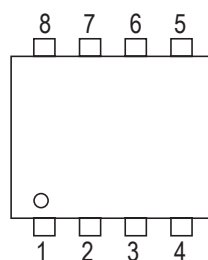

Top View

SOT-28FL / VEC8

TND323VD-TL-E
TND323VD-TL-H

- 1 : INA
- 2 : OUTA
- 3 : OUTB
- 4 : INB
- 5 : GND
- 6 : VDD
- 7 : VDD
- 8 : VDD

ORDERING INFORMATION

See detailed ordering and shipping information on page 7 of this data sheet.

TND323VD

Recommend Operating Conditions at Ta=25°C

Parameter	Symbol	Conditions	Ratings	Unit
Operating Supply Voltage	V _{DD}		4.5 to 25	V
Operating Temperature	T _{opr}		-40 to +125	°C

Functional operation above the stresses listed in the Recommended Operating Ranges is not implied. Extended exposure to stresses beyond the Recommended Operating Ranges limits may affect device reliability.

Electrical Characteristics (AC Characteristics) at Ta=25°C, V_{DD}=18V, V_{IN}=5V

Parameter	Symbol	Conditions	Ratings			Unit
			min	typ	max	
Turn-On Rise Time	t _r	C _L =1000pF		35	50	ns
Turn-Off Fall Time	t _f	C _L =1000pF		30	45	ns
Delay Time	t _{D1}	C _L =1000pF		30	45	ns
	t _{D2}	C _L =1000pF		45	60	ns

Electrical Characteristics (DC Characteristics) at Ta=25°C, V_{DD}=4.5 to 25V

Parameter	Symbol	Conditions	Ratings			Unit
			min	typ	max	
Logic "1" Input Voltage	V _{IH}		2.6			V
Logic "0" Input Voltage	V _{IL}				0.8	V
Logic "1" Input Bias Current	I _{IN+}	V _{IN} =V _{DD} =25V		40	100	μA
Logic "0" Input Bias Current	I _{IN-}	V _{IN} =0V	-1		1	μA
High-level Output Voltage	V _{OH}	I _O =0A	V _{DD} -0.1			V
Low-level Output Voltage	V _{OL}	I _O =0A			0.1	V
V _{DD} Supply Current	I _{supp}	V _{DD} =10V, V _{IN} =3V, (both inputs)		1.0	4.5	mA
		V _{DD} =10V, V _{IN} =0V, (both inputs)			0.2	mA
Output High Short Circuit Pulsed Current	I _{O+}	V _{DD} =18V, PW≤10μs, V _O UT=0V		0.8		A
Output Low Short Circuit Pulsed Current	I _{O-}	V _{DD} =18V, PW≤10μs, V _O UT=18V		1.0		A
Output On Resistance	R _{OUT}	V _{DD} =18V, I _{load} =10mA, V _O UT="H"		11	16.5	Ω
		V _{DD} =18V, I _{load} =10mA, V _O UT="L"		6	10	Ω

Product parametric performance is indicated in the Electrical Characteristics for the listed test conditions, unless otherwise noted. Product performance may not be indicated by the Electrical Characteristics if operated under different conditions.

Block Diagram

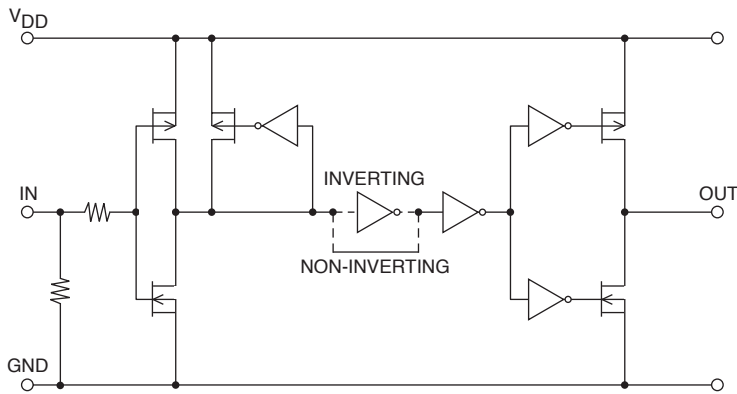

Switching Time Test Circuit

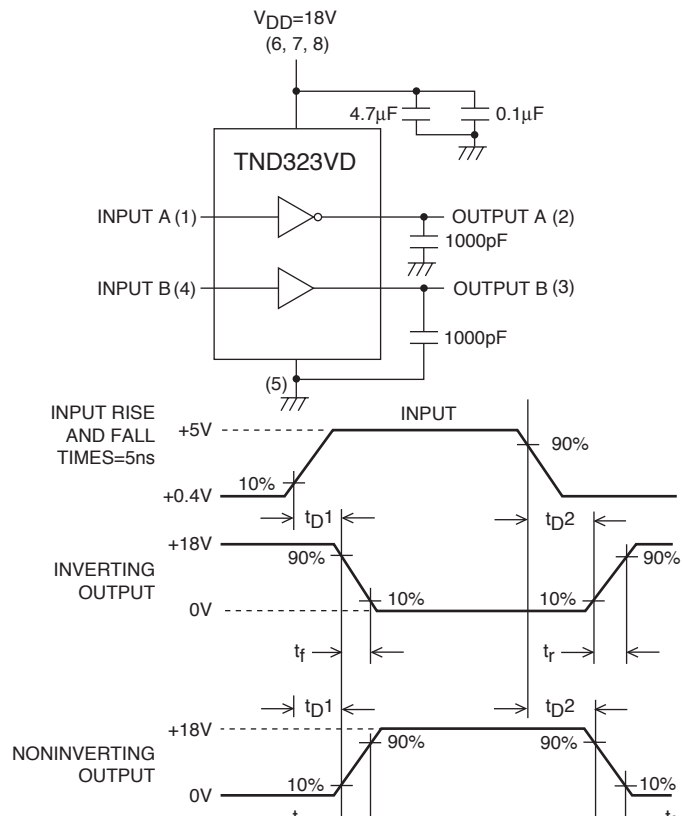

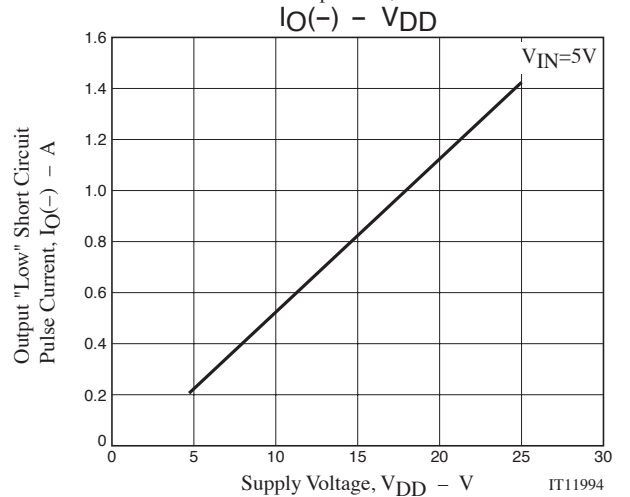
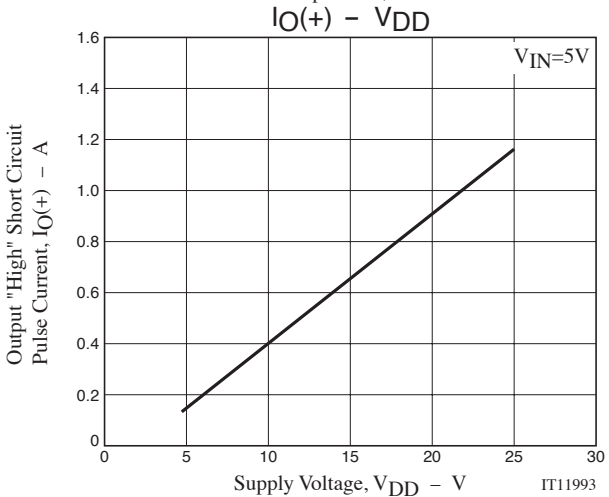
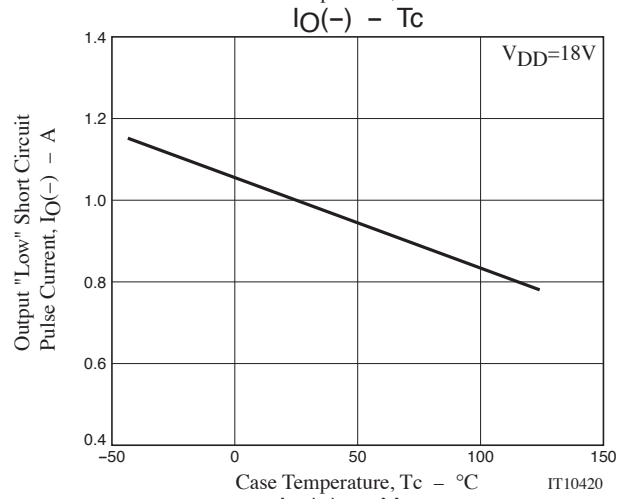
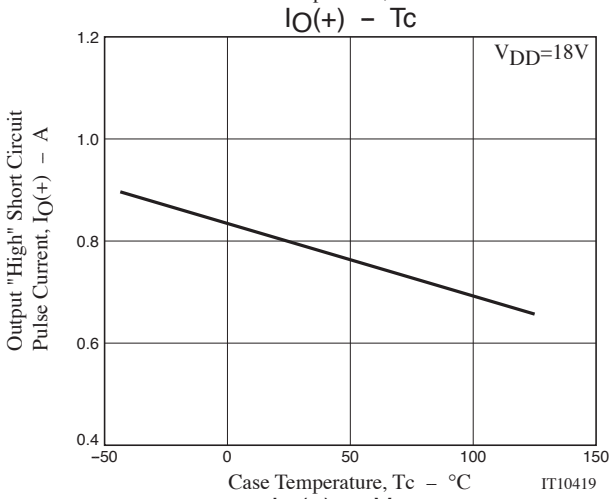
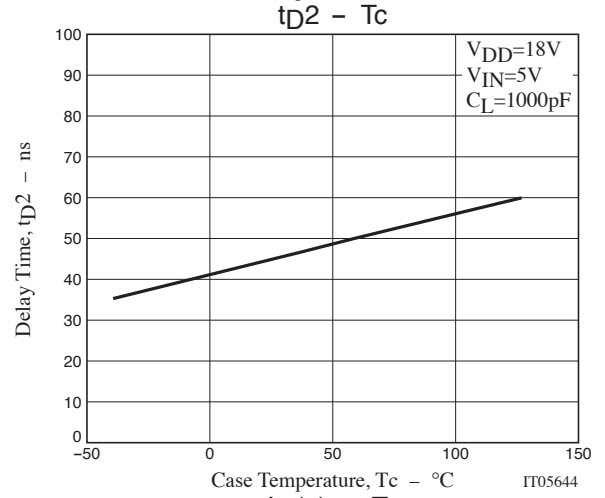
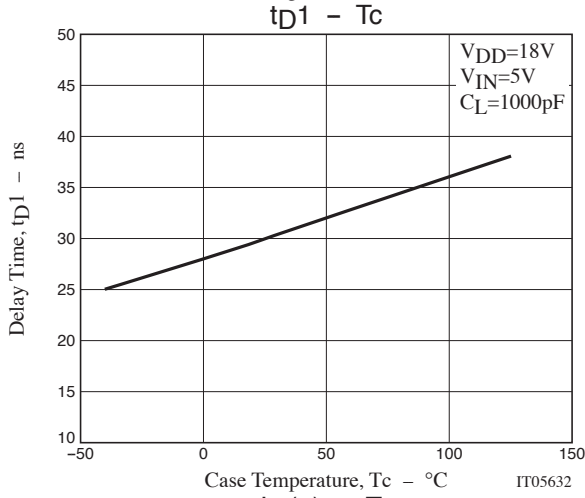
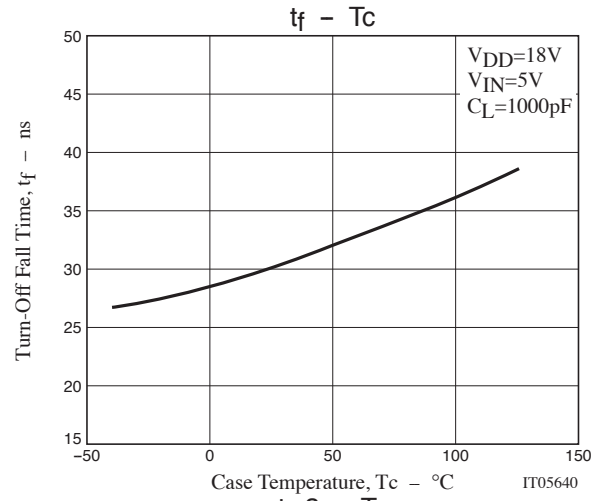
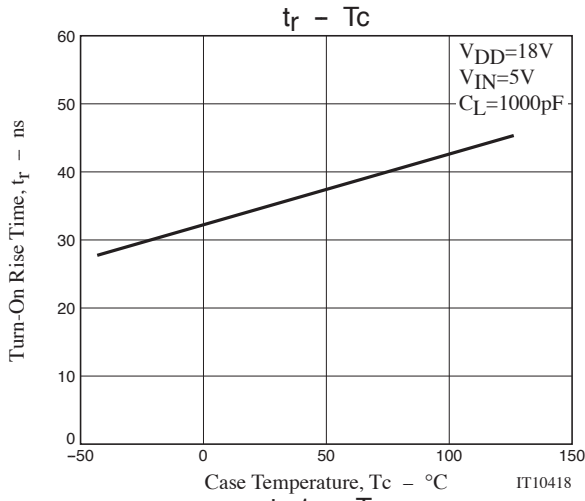

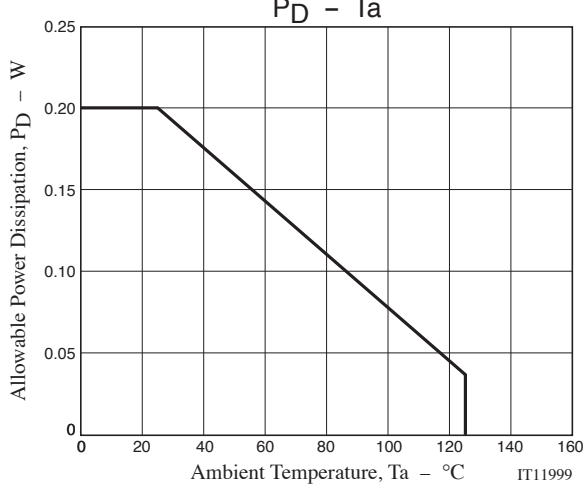
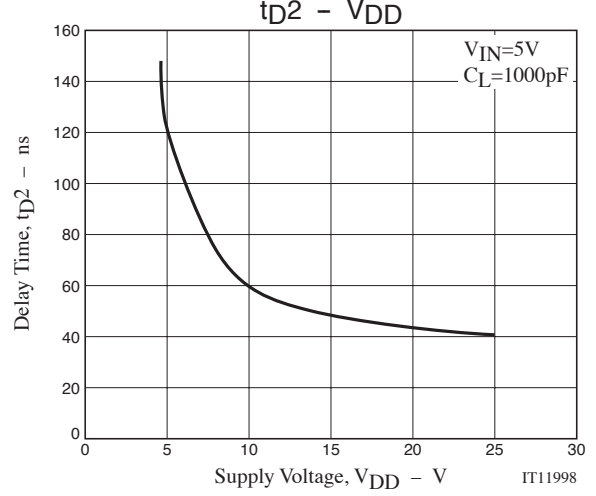
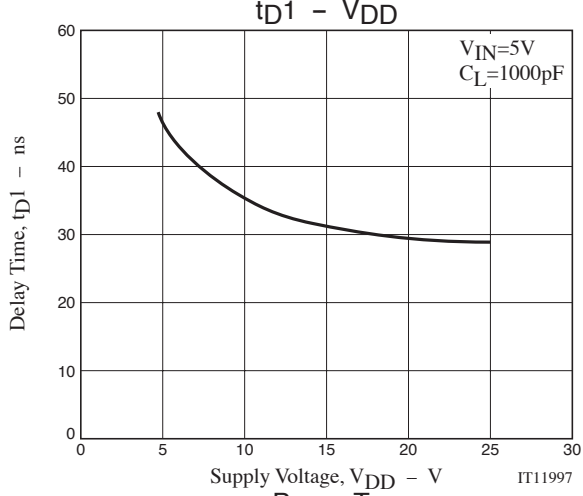
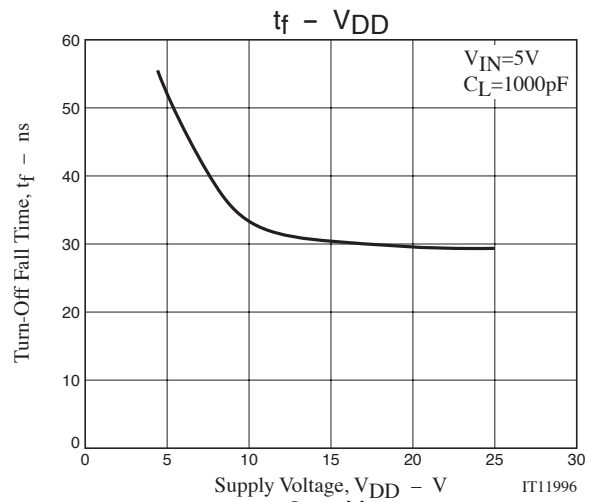
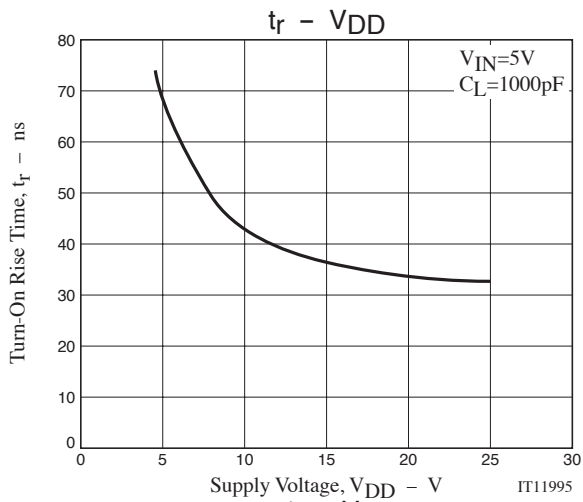

Package Dimensions

unit : mm

TND323VD-TL-E, TND323VD-TL-H

SOT-28FL / VEC8

CASE 318AH

ISSUE O

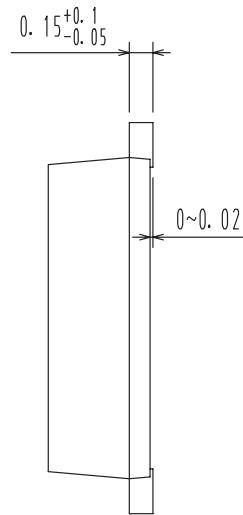
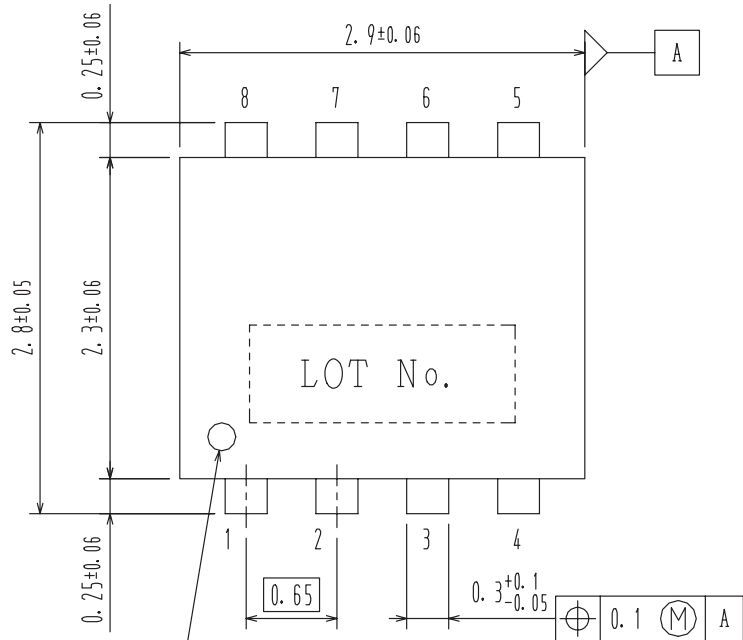

- 1 : INA
- 2 : OUTA
- 3 : OUTB
- 4 : INB
- 5 : GND
- 6 : VDD
- 7 : VDD
- 8 : VDD

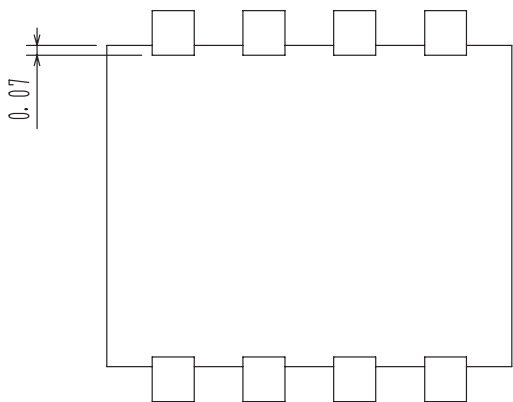
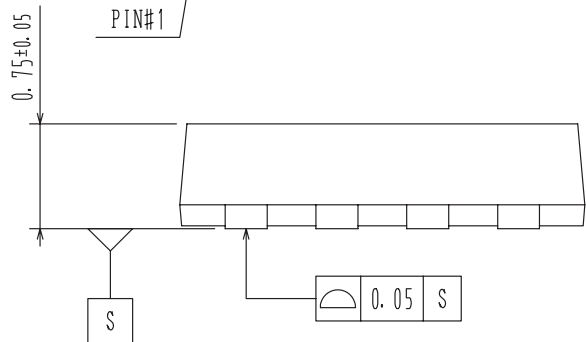

Recommended Soldering Footprint

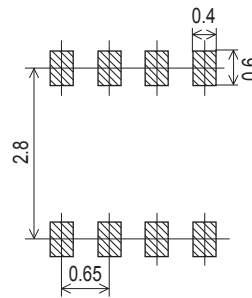

ORDERING INFORMATION

Device	Package	Shipping	memo
TND323VD-TL-E	SOT-28FL / VEC8	3,000pcs. / Tape and Reel	Pb-Free
TND323VD-TL-H	SOT-28FL / VEC8	3,000pcs. / Tape and Reel	Pb-Free and Halogen Free

ON Semiconductor and the ON logo are registered trademarks of Semiconductor Components Industries, LLC (SCILLC) or its subsidiaries in the United States and/or other countries. SCILLC owns the rights to a number of patents, trademarks, copyrights, trade secrets, and other intellectual property. A listing of SCILLC's product/patent coverage may be accessed at www.onsemi.com/site/pdf/Patent-Marking.pdf. SCILLC reserves the right to make changes without further notice to any products herein. SCILLC makes no warranty, representation or guarantee regarding the suitability of its products for any particular purpose, nor does SCILLC assume any liability arising out of the application or use of any product or circuit, and specifically disclaims any and all liability, including without limitation special, consequential or incidental damages. "Typical" parameters which may be provided in SCILLC data sheets and/or specifications can and do vary in different applications and actual performance may vary over time. All operating parameters, including "Typicals" must be validated for each customer application by customer's technical experts. SCILLC does not convey any license under its patent rights nor the rights of others. SCILLC products are not designed, intended, or authorized for use as components in systems intended for surgical implant into the body, or other applications intended to support or sustain life, or for any other application in which the failure of the SCILLC product could create a situation where personal injury or death may occur. Should Buyer purchase or use SCILLC products for any such unintended or unauthorized application, Buyer shall indemnify and hold SCILLC and its officers, employees, subsidiaries, affiliates, and distributors harmless against all claims, costs, damages, and expenses, and reasonable attorney fees arising out of, directly or indirectly, any claim of personal injury or death associated with such unintended or unauthorized use, even if such claim alleges that SCILLC was negligent regarding the design or manufacture of the part. SCILLC is an Equal Opportunity/Affirmative Action Employer. This literature is subject to all applicable copyright laws and is not for resale in any manner.