

## OptiMOS<sup>®</sup> 2 Power-Transistor

### Features

- Ideal for high-frequency dc/dc converters
- N-channel
- Logic level
- Excellent gate charge x  $R_{DS(on)}$  product (FOM)
- Very low on-resistance  $R_{DS(on)}$
- Superior thermal resistance
- 175 °C operating temperature
- dv/dt rated

### Product Summary

|                                |      |            |
|--------------------------------|------|------------|
| $V_{DS}$                       | 25   | V          |
| $R_{DS(on),max}$ (SMD version) | 13.6 | m $\Omega$ |
| $I_D$                          | 30   | A          |

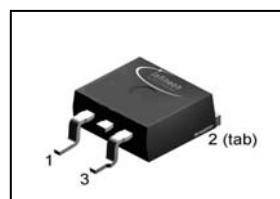
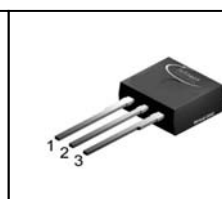
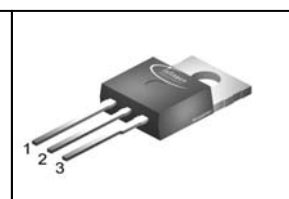
**P-TO263-3-2**

**P-TO262-3-1**

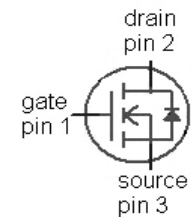
**P-TO220-3-1**

| Type       | Package     | Ordering Code | Marking |
|------------|-------------|---------------|---------|
| IPB14N03LA | P-TO263-3-2 | Q67042-S4156  | 14N03LA |
| IPI14N03LA | P-TO262-3-1 | Q67042-S4157  | 14N03LA |
| IPP14N03LA | P-TO220-3-1 | Q67042-S4158  | 14N03LA |



**Maximum ratings, at  $T_j=25\text{ °C}$ , unless otherwise specified**

| Parameter                           | Symbol            | Conditions  | Value       | Unit              |
|-------------------------------------|-------------------|---|-------------|-------------------|
| Continuous drain current            | $I_D$             | $T_C=25\text{ °C}^1)$   | 30          | A                 |
|                                     |                   | $T_C=100\text{ °C}$   | 30          |                   |
| Pulsed drain current                | $I_{D,pulse}$     | $T_C=25\text{ °C}^2)$   | 210         |                   |
| Avalanche energy, single pulse      | $E_{AS}$          | $I_D=24\text{ A}$ , $R_{GS}=25\ \Omega$   | 60          | mJ                |
| Reverse diode dv/dt                 | dv/dt             | $I_D=30\text{ A}$ , $V_{DS}=20\text{ V}$ ,<br>$di/dt=200\text{ A}/\mu\text{s}$ ,<br>$T_{j,max}=175\text{ °C}$ | 6           | kV/ $\mu\text{s}$ |
| Gate source voltage <sup>3)</sup>   | $V_{GS}$          |   | $\pm 20$    | V                 |
| Power dissipation                   | $P_{tot}$         | $T_C=25\text{ °C}$  | 46          | W                 |
| Operating and storage temperature   | $T_j$ , $T_{stg}$ |   | -55 ... 175 | °C                |
| IEC climatic category; DIN IEC 68-1 |                   |   | 55/175/56   |                   |

| Parameter | Symbol | Conditions | Values |      |      | Unit |
|-----------|--------|------------|--------|------|------|------|
|           |        |            | min.   | typ. | max. |      |

**Thermal characteristics**

|                                     |            |  |   |   |     |     |
|-------------------------------------|------------|--|---|---|-----|-----|
| Thermal resistance, junction - case | $R_{thJC}$ |  | - | - | 3.2 | K/W |
| SMD version, device on PCB          | $R_{thJA}$ | minimal footprint                            | - | - | 62  |     |
|                                     |            | 6 cm <sup>2</sup> cooling area <sup>4)</sup> | - | - | 40  |     |

**Electrical characteristics, at  $T_j=25\text{ °C}$ , unless otherwise specified**
**Static characteristics**

|                                  |               |  |     |      |      |               |
|----------------------------------|---------------|--|-----|------|------|---------------|
| Drain-source breakdown voltage   | $V_{(BR)DSS}$ | $V_{GS}=0\text{ V}, I_D=1\text{ mA}$                       | 25  | -    | -    | V             |
| Gate threshold voltage           | $V_{GS(th)}$  | $V_{DS}=V_{GS}, I_D=20\text{ }\mu\text{A}$                 | 1.2 | 1.6  | 2    |               |
| Zero gate voltage drain current  | $I_{DSS}$     | $V_{DS}=25\text{ V}, V_{GS}=0\text{ V}, T_j=25\text{ °C}$  | -   | 0.1  | 1    | $\mu\text{A}$ |
|                                  |               | $V_{DS}=25\text{ V}, V_{GS}=0\text{ V}, T_j=125\text{ °C}$ | -   | 10   | 100  |               |
| Gate-source leakage current      | $I_{GSS}$     | $V_{GS}=20\text{ V}, V_{DS}=0\text{ V}$                    | -   | 10   | 100  | nA            |
| Drain-source on-state resistance | $R_{DS(on)}$  | $V_{GS}=4.5\text{ V}, I_D=20\text{ A}$                     | -   | 18.5 | 23.1 | m $\Omega$    |
|                                  |               | $V_{GS}=4.5\text{ V}, I_D=20\text{ A},$<br>SMD version     | -   | 18.2 | 22.7 |               |
|                                  |               | $V_{GS}=10\text{ V}, I_D=30\text{ A}$                      | -   | 11.6 | 13.9 |               |
|                                  |               | $V_{GS}=10\text{ V}, I_D=30\text{ A},$<br>SMD version      | -   | 11.3 | 13.6 |               |
| Gate resistance                  | $R_G$         |  | -   | 0.9  | -    | $\Omega$      |
| Transconductance                 | $g_{fs}$      | $ V_{DS} >2 I_D R_{DS(on)max},$<br>$I_D=30\text{ A}$       | 17  | 33   | -    | S             |

<sup>1)</sup> Current is limited by bondwire; with an  $R_{thJC}=3.2\text{ K/W}$  the chip is able to carry 45 A.

<sup>2)</sup> See figure 3

<sup>3)</sup>  $T_{j,max}=150\text{ °C}$  and duty cycle  $D<0.25$  for  $V_{GS}<-5\text{ V}$

<sup>4)</sup> Device on 40 mm x 40 mm x 1.5 mm epoxy PCB FR4 with 6 cm<sup>2</sup> (one layer, 70  $\mu\text{m}$  thick) copper area for drain connection. PCB is vertical in still air.

| Parameter | Symbol | Conditions | Values |      |      | Unit |
|-----------|--------|------------|--------|------|------|------|
|           |        |            | min.   | typ. | max. |      |

**Dynamic characteristics**

|                              |              |  |   |     |      |    |
|------------------------------|--------------|--|---|-----|------|----|
| Input capacitance            | $C_{iss}$    | $V_{GS}=0\text{ V}, V_{DS}=15\text{ V}, f=1\text{ MHz}$                    | - | 849 | 1129 | pF |
| Output capacitance           | $C_{oss}$    |  | - | 364 | 484  |    |
| Reverse transfer capacitance | $C_{rss}$    |  | - | 58  | 87   |    |
| Turn-on delay time           | $t_{d(on)}$  | $V_{DD}=15\text{ V}, V_{GS}=10\text{ V}, I_D=20\text{ A}, R_G=2.7\ \Omega$ | - | 7   | 10   | ns |
| Rise time                    | $t_r$        |  | - | 27  | 41   |    |
| Turn-off delay time          | $t_{d(off)}$ |  | - | 18  | 27   |    |
| Fall time                    | $t_f$        |  | - | 3.4 | 5    |    |

**Gate Charge Characteristics<sup>5)</sup>**

|                              |               |  |   |     |     |    |
|------------------------------|---------------|--|---|-----|-----|----|
| Gate to source charge        | $Q_{gs}$      | $V_{DD}=15\text{ V}, I_D=15\text{ A}, V_{GS}=0\text{ to }5\text{ V}$ | - | 2.9 | 3.9 | nC |
| Gate charge at threshold     | $Q_{g(th)}$   |  | - | 1.4 | 1.8 |    |
| Gate to drain charge         | $Q_{gd}$      |  | - | 2.2 | 3.2 |    |
| Switching charge             | $Q_{sw}$      |  | - | 3.7 | 5.3 |    |
| Gate charge total            | $Q_g$         |  | - | 7.0 | 9.3 |    |
| Gate plateau voltage         | $V_{plateau}$ |  | - | 3.4 | -   | V  |
| Gate charge total, sync. FET | $Q_{g(sync)}$ | $V_{DS}=0.1\text{ V}, V_{GS}=0\text{ to }5\text{ V}$                 | - | 6.0 | 7.9 | nC |
| Output charge                | $Q_{oss}$     | $V_{DD}=15\text{ V}, V_{GS}=0\text{ V}$                              | - | 8   | 10  |    |

**Reverse Diode**

|                                  |               |  |   |      |     |    |
|----------------------------------|---------------|--|---|------|-----|----|
| Diode continuous forward current | $I_S$         | $T_C=25\text{ }^\circ\text{C}$                                     | - | -    | 30  | A  |
| Diode pulse current              | $I_{S,pulse}$ |  | - | -    | 210 |    |
| Diode forward voltage            | $V_{SD}$      | $V_{GS}=0\text{ V}, I_F=30\text{ A}, T_J=25\text{ }^\circ\text{C}$ | - | 0.97 | 1.2 | V  |
| Reverse recovery charge          | $Q_{rr}$      | $V_R=15\text{ V}, I_F=I_S, di_F/dt=400\text{ A}/\mu\text{s}$       | - | -    | 10  | nC |

<sup>5)</sup> See figure 16 for gate charge parameter definition

**1 Power dissipation**

$P_{tot}=f(T_C)$

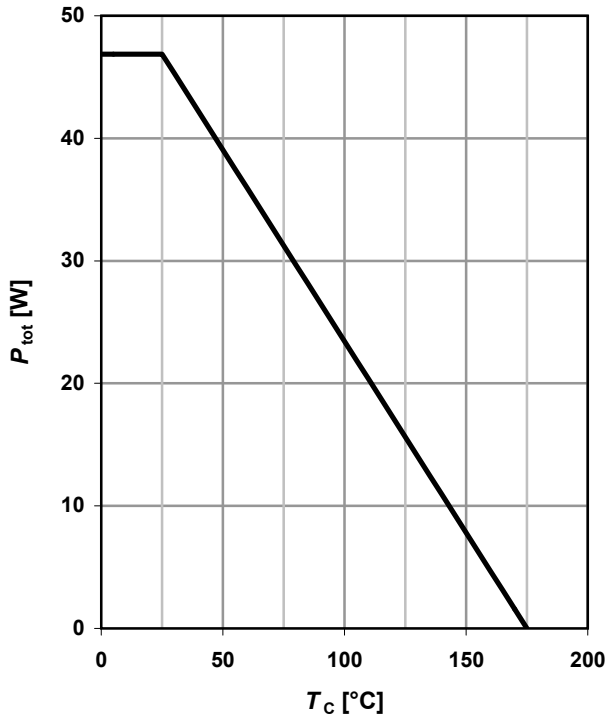

**2 Drain current**

$I_D=f(T_C); V_{GS} \geq 10\text{ V}$

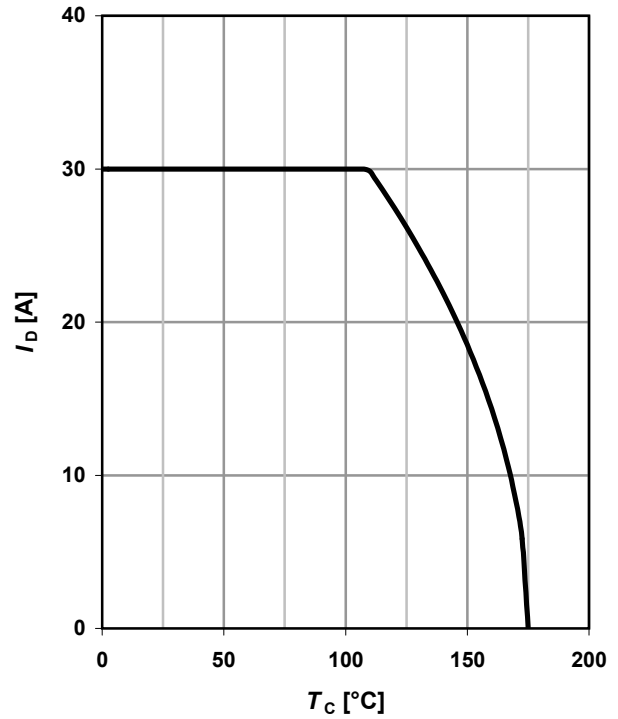

**3 Safe operation area**

$I_D=f(V_{DS}); T_C=25\text{ °C}; D=0$

parameter:  $t_p$

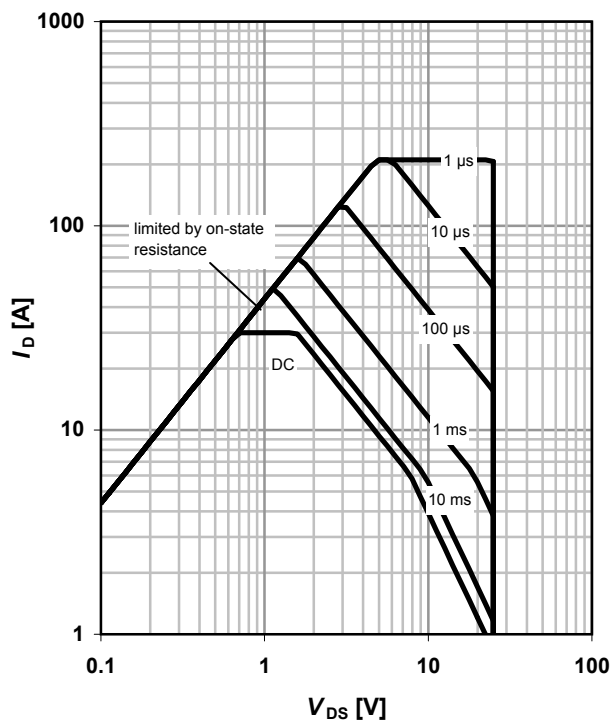

**4 Max. transient thermal impedance**

$Z_{thJC}=f(t_p)$

parameter:  $D=t_p/T$

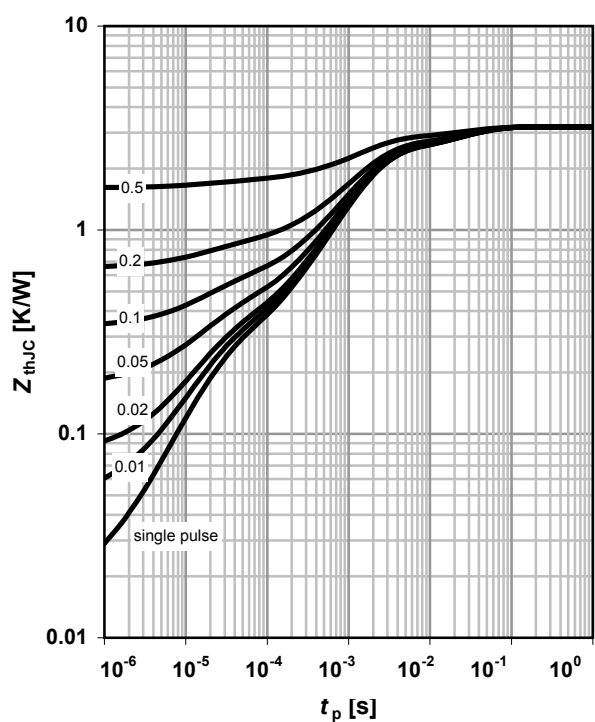

**5 Typ. output characteristics**

$I_D = f(V_{DS}); T_j = 25\text{ }^\circ\text{C}$

parameter:  $V_{GS}$

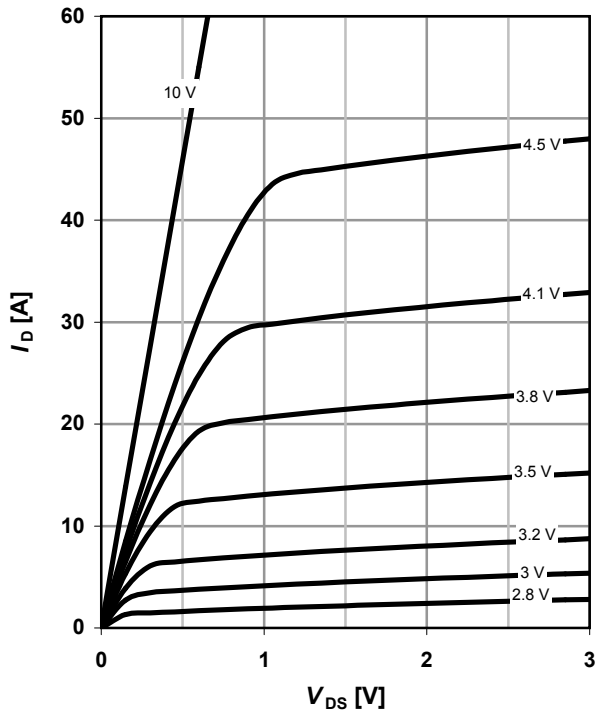

**6 Typ. drain-source on resistance**

$R_{DS(on)} = f(I_D); T_j = 25\text{ }^\circ\text{C}$

parameter:  $V_{GS}$

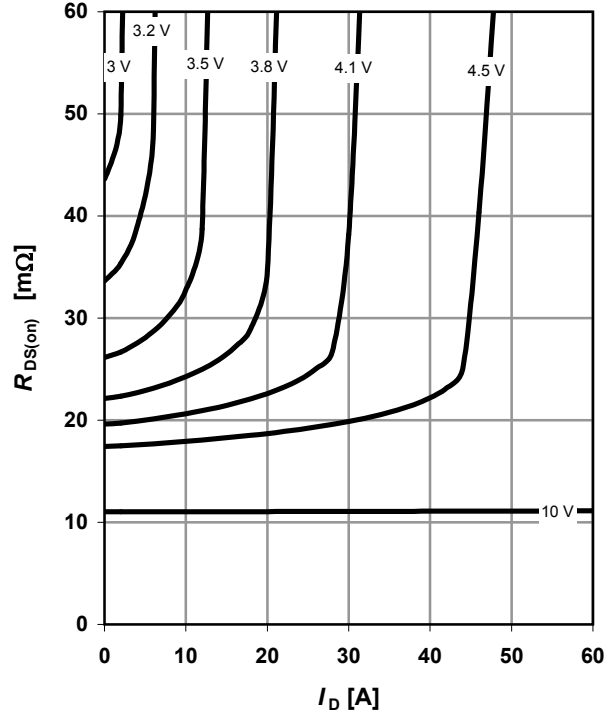

**7 Typ. transfer characteristics**

$I_D = f(V_{GS}); |V_{DS}| > 2|I_D|R_{DS(on)max}$

parameter:  $T_j$

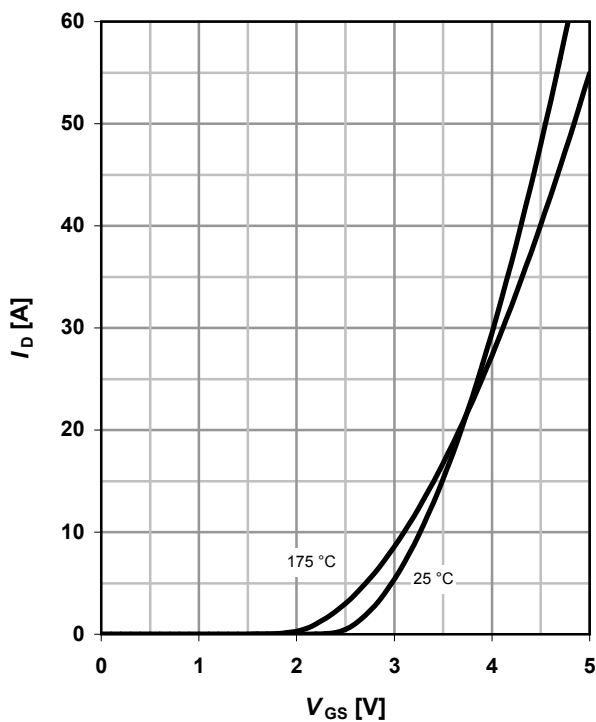

**8 Typ. forward transconductance**

$g_{fs} = f(I_D); T_j = 25\text{ }^\circ\text{C}$

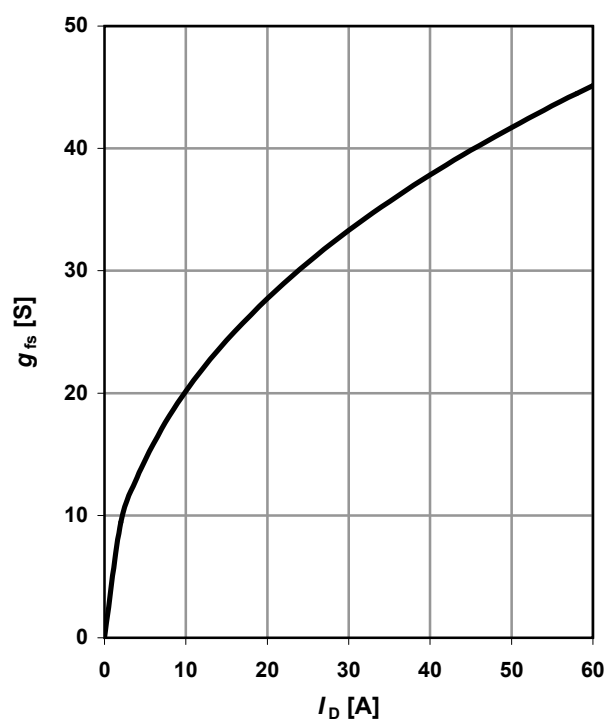

**9 Drain-source on-state resistance**

$R_{DS(on)} = f(T_j); I_D = 30 \text{ A}; V_{GS} = 10 \text{ V}$

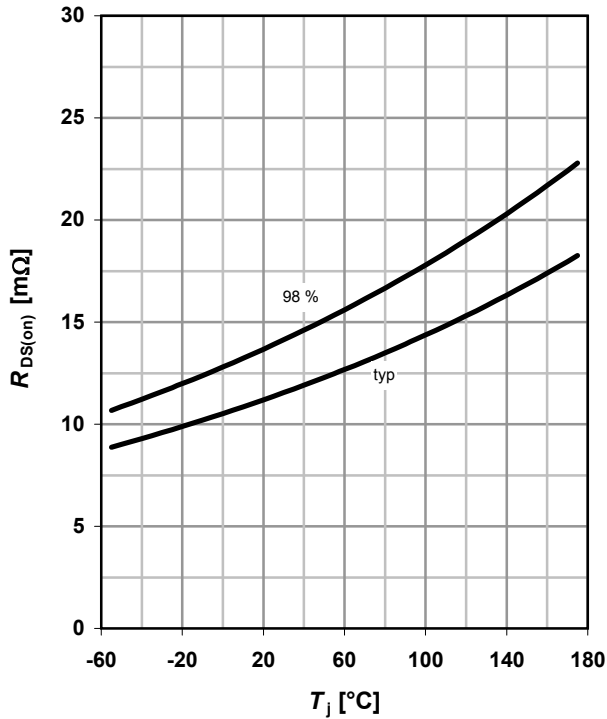

**10 Typ. gate threshold voltage**

$V_{GS(th)} = f(T_j); V_{GS} = V_{DS}$

parameter:  $I_D$

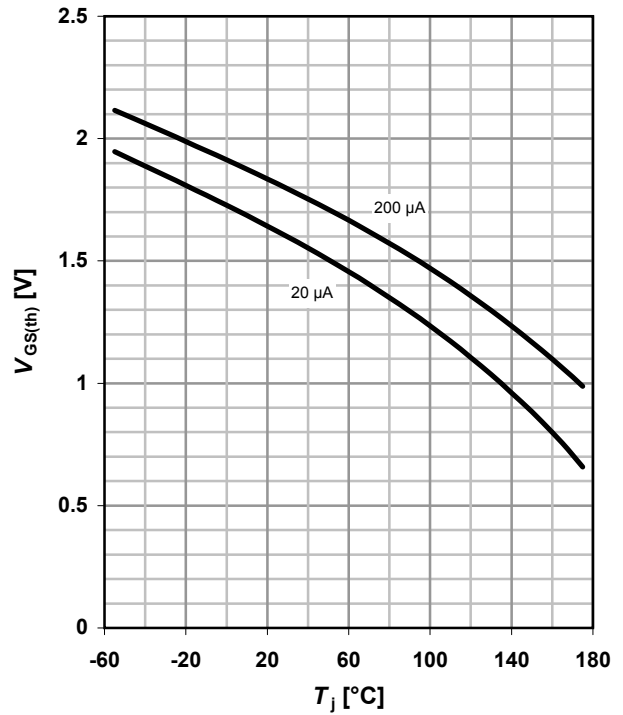

**11 Typ. Capacitances**

$C = f(V_{DS}); V_{GS} = 0 \text{ V}; f = 1 \text{ MHz}$

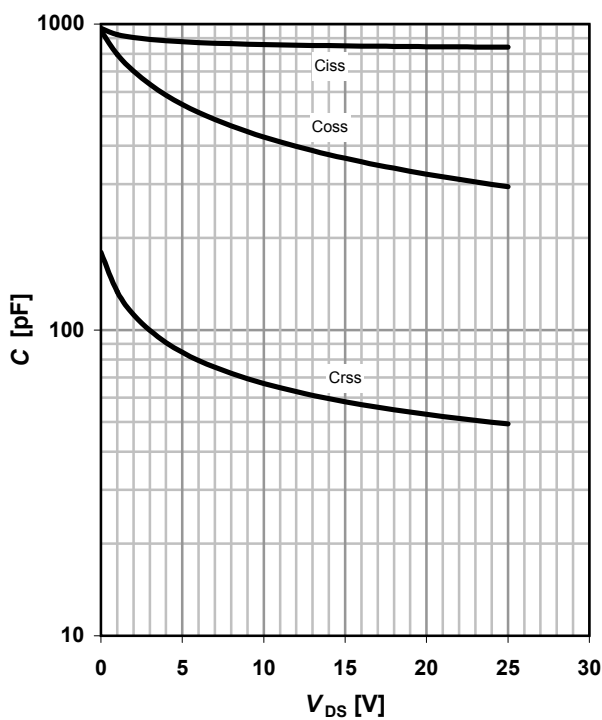

**12 Forward characteristics of reverse diode**

$I_F = f(V_{SD})$

parameter:  $T_j$

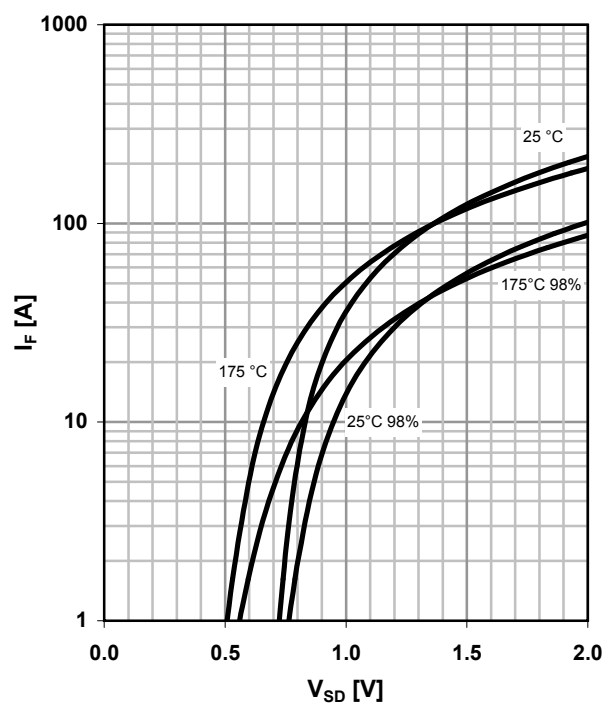

**13 Avalanche characteristics**

$I_{AS}=f(t_{AV}); R_{GS}=25\ \Omega$

parameter:  $T_{j(start)}$

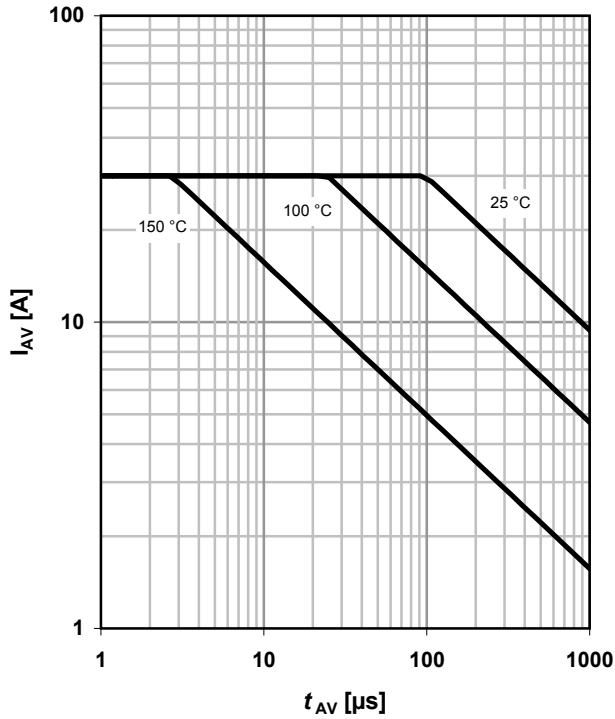

**14 Typ. gate charge**

$V_{GS}=f(Q_{gate}); I_D=15\ A\ pulsed$

parameter:  $V_{DD}$

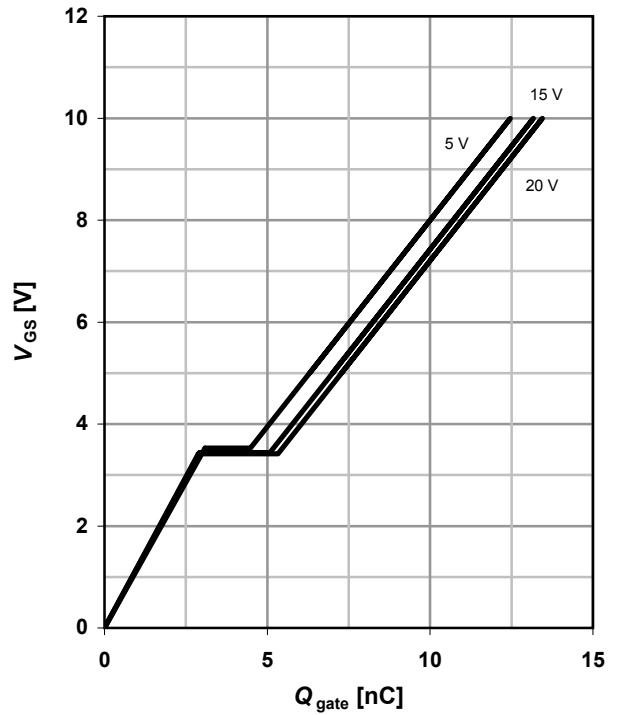

**15 Drain-source breakdown voltage**

$V_{BR(DSS)}=f(T_j); I_D=1\ mA$

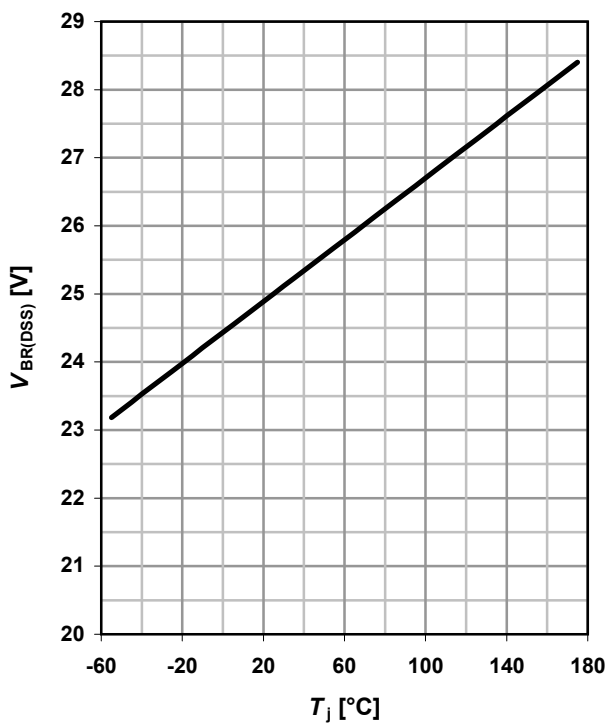

**16 Gate charge waveforms**

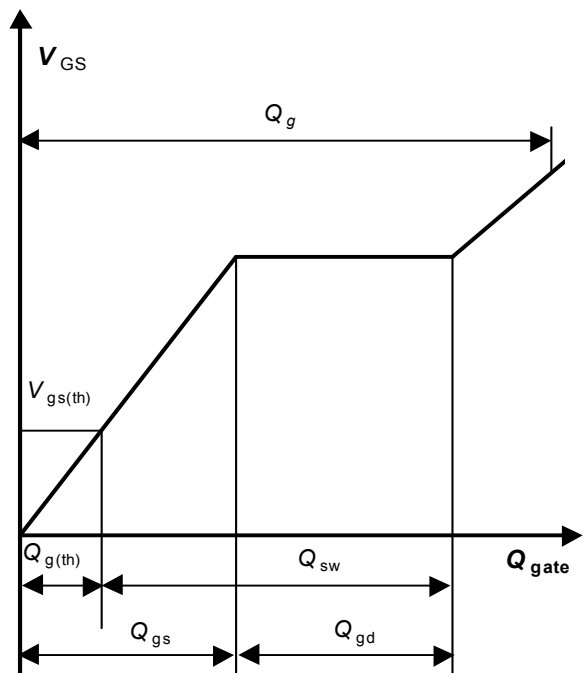

Package Outline

P-TO263-3-2: Outline

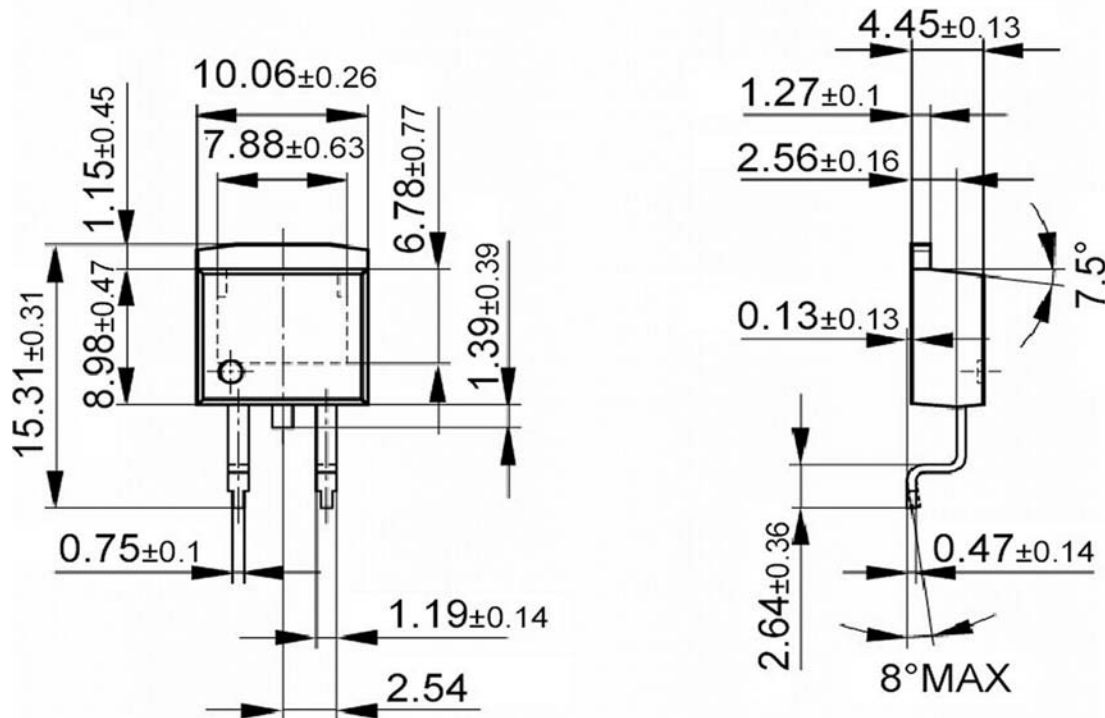

Footprint

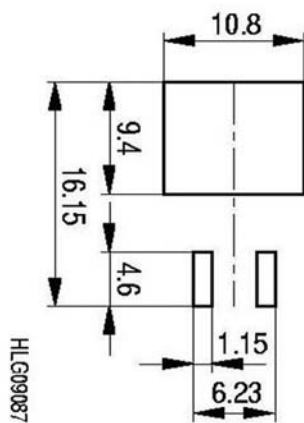

Packaging

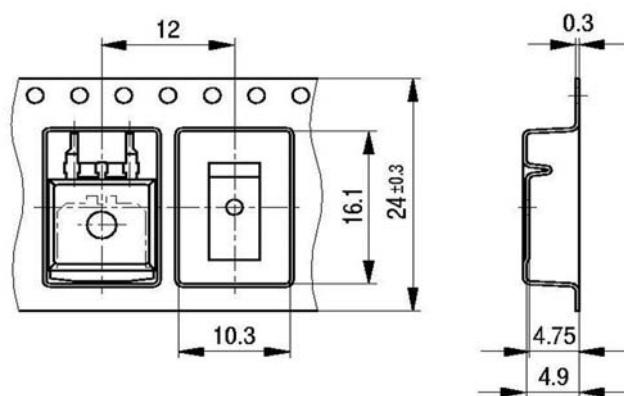

Dimensions in mm



P-TO262-3-1: Outline

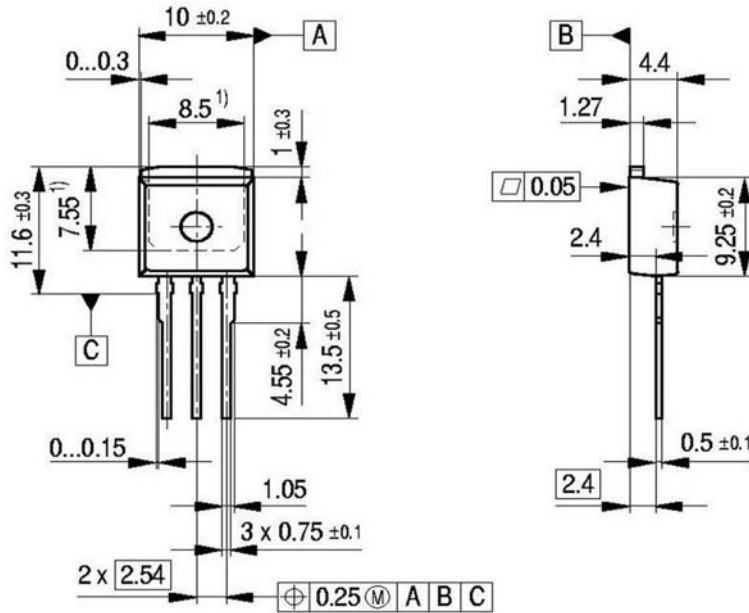

1) Typical

Metal surface min. X = 7.25, Y = 6.9

All metal surfaces tin plated, except area of cut.

P-TO220-3-1: Outline

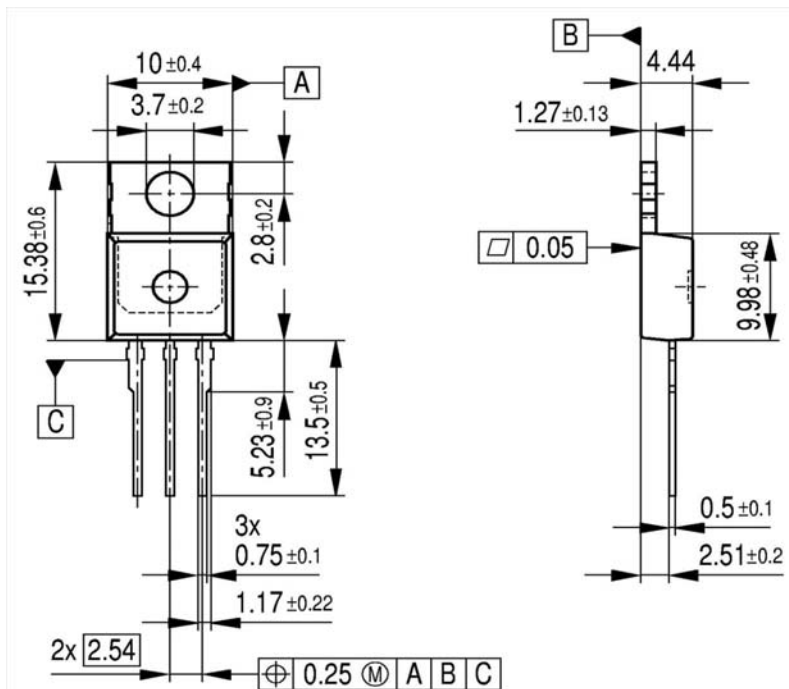

All metal surfaces tin plated, except area of cut.  
Metal surface min. x=7.25, y=12.3

Dimensions in mm

Packaging

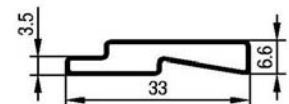

**Published by**  
**Infineon Technologies AG**  
**Bereich Kommunikation**  
**St.-Martin-Straße 53**  
**D-81541 München**  
**© Infineon Technologies AG 1999**  
**All Rights Reserved.**

**Attention please!**

The information herein is given to describe certain components and shall not be considered as warranted characteristics.

Terms of delivery and rights to technical change reserved.

We hereby disclaim any and all warranties, including but not limited to warranties of non-infringement, regarding circuits, descriptions and charts started herein.

Infineon Technologies is an approved CECC manufacturer.

**Information**

For further information on technology, delivery terms and conditions and prices, please contact your nearest Infineon Technologies office in Germany or our Infineon Technologies representatives worldwide (see address list).

**Warnings**

Due to technical requirements, components may contain dangerous substances.  
For information on the types in question, please contact your nearest Infineon Technologies office.

Infineon Technologies' components may only be used in life-support devices or systems with the expressed written approval of Infineon Technologies if a failure of such components can reasonably be expected to cause the failure of that life-support device or system, or to affect the safety or effectiveness of that device or system. Life support devices or systems are intended to be implanted in the human body, or to support and/or maintain and sustain and/or protect human life. If they fail, it is reasonable to assume that the health of the user or other persons may be endangered.

This datasheet has been download from:

[www.datasheetcatalog.com](http://www.datasheetcatalog.com)

Datasheets for electronics components.