

# 2MHz High-Brightness LED Drivers with High-Side Current Sense and 5000:1 Dimming

## General Description

The MAX16819/MAX16820, step-down constant-current high-brightness LED (HB LED) drivers provide a cost-effective solution for automotive interior/exterior lighting, architectural and ambient lighting, LED bulbs such as MR16 and other LED illumination applications.

The MAX16819/MAX16820 operate from a 4.5V to 28V input voltage range and feature a 5V/10mA on-board regulator. A high-side current-sense resistor adjusts the output current and a dedicated PWM input (DIM) enables a wide range of pulsed dimming.

The MAX16819/MAX16820 are well suited for applications requiring a wide input voltage range. The high-side current-sensing and an integrated current-setting circuitry minimize the number of external components while delivering an LED current with  $\pm 5\%$  accuracy. A hysteretic control algorithm ensures excellent input-supply rejection and fast response during load transients and PWM dimming. The MAX16819 features a 30% inductor current ripple and the MAX16820 features a 10% current ripple. These devices operate up to 2MHz switching frequency, thus allowing for small component size.

The MAX16819/MAX16820 operate over the  $-40^{\circ}\text{C}$  to  $+125^{\circ}\text{C}$  automotive temperature range and are available in 3mm x 3mm x 0.8mm, 6-pin TDFN packages.

## Applications

Architectural, Industrial, and Ambient Lighting  
Automotive RCL, DRL, and Fog Lights  
MR16 and Other LED Bulbs  
Indicators and Emergency Lighting

## Pin Configuration

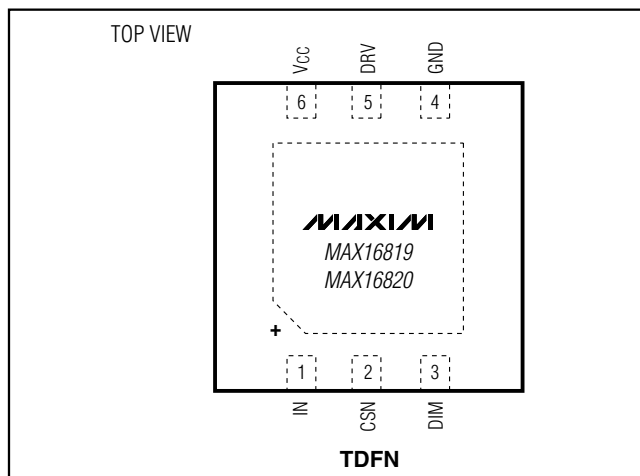

## Features

- ◆ High-Side Current Sense
- ◆ Dedicated Dimming Control Input
- ◆ 20kHz Maximum Dimming Frequency
- ◆ Hysteretic Control: No Compensation
- ◆ Up to 2MHz Switching Frequency
- ◆  $\pm 5\%$  LED Current Accuracy
- ◆ Adjustable Constant LED Current
- ◆ 4.5V to 28V Input Voltage Range
- ◆ Over 25W Output Power
- ◆ 5V, 10mA On-Board Regulator
- ◆  $-40^{\circ}\text{C}$  to  $+125^{\circ}\text{C}$  Operating Temperature Range

## Ordering Information

PART	PIN-PACKAGE	PKG CODE	TOP MARK
MAX16819ATT+T	6 TDFN-EP*	T633-2	+ATB
MAX16820ATT+T	6 TDFN-EP*	T633-2	+ATC

**Note:** All devices are specified over the  $-40^{\circ}\text{C}$  to  $+125^{\circ}\text{C}$  operating temperature range.

+Denotes lead-free package.

\*EP = Exposed paddle.

## Typical Operating Circuit

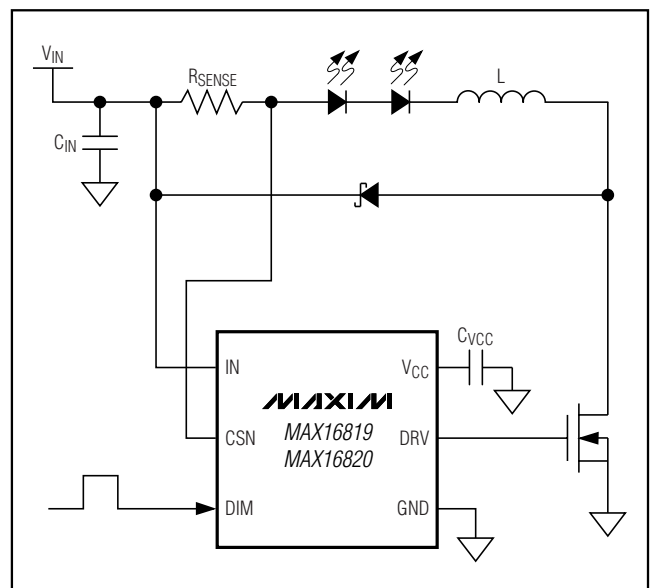

# 2MHz High-Brightness LED Drivers with High-Side Current Sense and 5000:1 Dimming

## ABSOLUTE MAXIMUM RATINGS

IN, CSN, DIM to GND .....	-0.3V to +30V
V <sub>CC</sub> , DRV to GND .....	-0.3V to +6V
CSN to IN.....	-0.3V to +0.3V
Maximum Current into Any Pin (except IN, V <sub>CC</sub> , and DRV).....	±20mA
Continuous Power Dissipation (T <sub>A</sub> = +70°C) 6-Pin TDFN (derate 18.17mW/°C* above +70°C).....	1454mW

Operating Temperature Range .....	-40°C to +125°C
Junction Temperature.....	+150°C
Storage Temperature Range .....	-65°C to +150°C
Lead Temperature (soldering, 10s).....	+300°C
Pin-to-Pin ESD Ratings (HB Model).....	2.5kV
*As per JEDEC51 Standard (Single-Layer Board).	

Stresses beyond those listed under "Absolute Maximum Ratings" may cause permanent damage to the device. These are stress ratings only, and functional operation of the device at these or any other conditions beyond those indicated in the operational sections of the specifications is not implied. Exposure to absolute maximum rating conditions for extended periods may affect device reliability.

## ELECTRICAL CHARACTERISTICS

(V<sub>IN</sub> = 12V, V<sub>DIM</sub> = V<sub>IN</sub>, C<sub>VCC</sub> = 1μF, R<sub>SENSE</sub> = 0.5Ω, T<sub>A</sub> = T<sub>J</sub> = -40°C to +125°C, unless otherwise noted. Typical values are at T<sub>A</sub> = +25°C.) (Note 1)

PARAMETER	SYMBOL	CONDITIONS	MIN	TYP	MAX	UNITS
Input Voltage Range	V <sub>IN</sub>		4.5		28.0	V
Maximum Current Regulator Switching Frequency	f <sub>sw</sub>				2	MHz
Ground Current	I <sub>GND</sub>	DRV open			1.5	mA
Supply Current	I <sub>IN</sub>	V <sub>DIM</sub> < 0.6V			425	μA
Undervoltage Lockout	UVLO	V <sub>IN</sub> = V <sub>CSN</sub> = V <sub>DIM</sub> , V <sub>IN</sub> rising from 4V until V <sub>DRV</sub> > V <sub>CC</sub> - 0.5V		4.7	5.0	V
		V <sub>IN</sub> = V <sub>CSN</sub> = V <sub>DIM</sub> , V <sub>IN</sub> falling from 6V, V <sub>DRV</sub> < 0.5V			4.5	
Undervoltage Lockout Hysteresis				0.5		V
<b>SENSE COMPARATOR</b>						
Sense Voltage Threshold High	V <sub>SNSHI</sub>	(V <sub>IN</sub> - V <sub>CSN</sub> ) rising from 0V until V <sub>DRV</sub> < 0.5V (MAX16820)	195	210	225	mV
		(V <sub>IN</sub> - V <sub>CSN</sub> ) rising from 0V until V <sub>DRV</sub> < 0.5V (MAX16819)	213	230	246	
Sense Voltage Threshold Low	V <sub>SNSLO</sub>	(V <sub>IN</sub> - V <sub>CSN</sub> ) falling from 0.26V until V <sub>DRV</sub> > (V <sub>CC</sub> - 0.5V) (MAX16820)	176	190	204	mV
		(V <sub>IN</sub> - V <sub>CSN</sub> ) falling from 0.26V until V <sub>DRV</sub> > (V <sub>CC</sub> - 0.5V) (MAX16819)	158	170	182	
Propagation Delay to Output High	t <sub>DPDH</sub>	Falling edge of (V <sub>IN</sub> - V <sub>CSN</sub> ) from 0.26V to 0V to DRV high, C <sub>DRV</sub> = 1nF		82		ns
Propagation Delay to Output Low	t <sub>DPDL</sub>	Rising edge of (V <sub>IN</sub> - V <sub>CSN</sub> ) from 0V to 0.26V to DRV low, C <sub>DRV</sub> = 1nF		82		ns
Current-Sense Input Current	I <sub>CSN</sub>	(V <sub>IN</sub> - V <sub>CSN</sub> ) = 200mV			1	μA
Current-Sense Threshold Hysteresis	C <sub>SHYS</sub>	MAX16819		56	70	mV
		MAX16820		17	35	mV

# 2MHz High-Brightness LED Drivers with High-Side Current Sense and 5000:1 Dimming

MAX16819/MAX16820

## ELECTRICAL CHARACTERISTICS (continued)

( $V_{IN} = 12V$ ,  $V_{DIM} = V_{IN}$ ,  $C_{VCC} = 1\mu F$ ,  $R_{SENSE} = 0.5\Omega$ ,  $T_A = T_J = -40^\circ C$  to  $+125^\circ C$ , unless otherwise noted. Typical values are at  $T_A = +25^\circ C$ .) (Note 1)

PARAMETER	SYMBOL	CONDITIONS	MIN	TYP	MAX	UNITS
<b>GATE DRIVER</b>						
Gate Driver Source Current		$V_{CSN} = V_{IN}$ , $V_{DRV} = 0.5 \times V_{CC}$		0.5		A
Gate Driver Sink Current		$V_{CSN} = V_{IN} - 250mV$ , $V_{DRV} = 0.5 \times V_{CC}$		1		A
Gate Driver Output-Voltage High	$V_{OH}$	$I_{DRV} = 10mA$	$V_{CC} - 0.5$			V
Gate Driver Output-Voltage Low	$V_{OL}$	$I_{DRV} = -10mA$			0.5	V
<b>DIM INPUT</b>						
Maximum DIM Frequency	$f_{DIM}$				20	kHz
DIM Input-Voltage High	$V_{IH}$	$V_{CSN} = V_{IN}$ , increase DIM until $V_{DRV} > (V_{CC} - 0.5V)$	2.8			V
DIM Input-Voltage Low	$V_{IL}$	$V_{CSN} = V_{IN}$ , decrease DIM until $V_{DRV} < 0.5V$			0.6	V
DIM Hysteresis	$DIM_{HYS}$			200		mV
DIM Turn-On Time	$t_{DIMON}$	DIM rising edge to $V_{DRV} = 0.5 \times V_{CC}$ , $C_{DRV} = 1nF$		100		ns
DIM Turn-Off Time	$t_{DIMOFF}$	DIM falling edge to $V_{DRV} = 0.5 \times V_{CC}$ , $C_{DRV} = 1nF$		100		ns
DIM Input Leakage High		$V_{DIM} = V_{IN}$			10	$\mu A$
DIM Input Leakage Low		$V_{DIM} = 0V$	-1		+1	$\mu A$
<b>V<sub>CC</sub> REGULATOR</b>						
Regulator Output Voltage	$V_{CC}$	$I_{VCC} = 0.1mA$ to $10mA$ , $V_{IN} = 5.5V$ to $28V$	4.5		5.5	V
		$I_{VCC} = 0.1mA$ to $10mA$ , $V_{IN} = 4.5V$ to $28V$	4.0		5.5	V
Load Regulation		$I_{VCC} = 0.1mA$ to $10mA$ , $V_{IN} = 12V$		4		$\Omega$
Line Regulation		$V_{IN} = 6V$ to $28V$ , $I_{VCC} = 10mA$		11		mV
Power-Supply Rejection Ratio	PSRR	$V_{IN} = 12V$ , $I_{VCC} = 5mA$ , $f_{IN} = 10kHz$		-35		dB
Current Limit	$I_{LIM}$	$V_{IN} = 4.5V$ , $V_{CC} = 0V$		45		mA
		$V_{IN} = 4.5V$ , $V_{CC} = 4V$		18		mA
Regulator Startup Time	$t_{STRAT}$	$V_{CC} = 0$ to $4.5V$		350		$\mu s$

**Note 1:** All devices are 100% production tested at  $T_J = +25^\circ C$  and  $+125^\circ C$ . Limits to  $-40^\circ C$  are guaranteed by design.

# 2MHz High-Brightness LED Drivers with High-Side Current Sense and 5000:1 Dimming

## Typical Operating Characteristics

( $V_{IN} = V_{DIM} = 12V$ ,  $C_{VCC} = 1\mu F$ ,  $R_{SENSE} = 0.5\Omega$  connected between IN and CSN. Typical values at  $T_A = +25^\circ C$ , unless otherwise noted.)

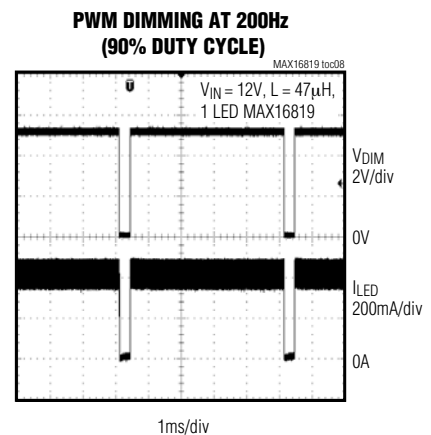
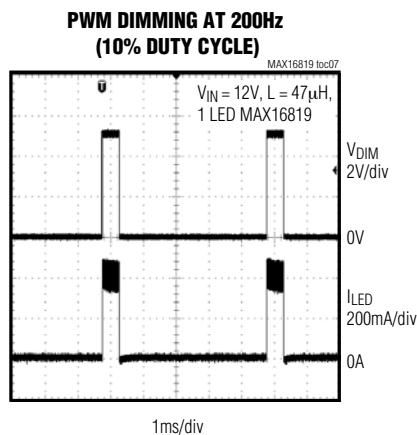
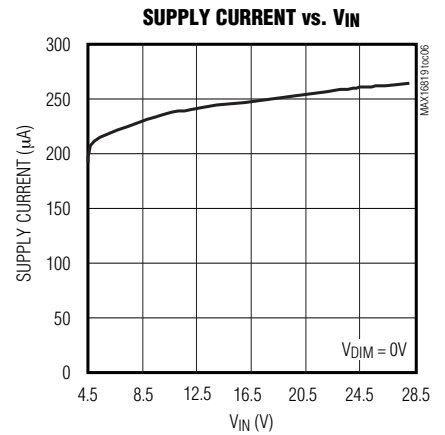
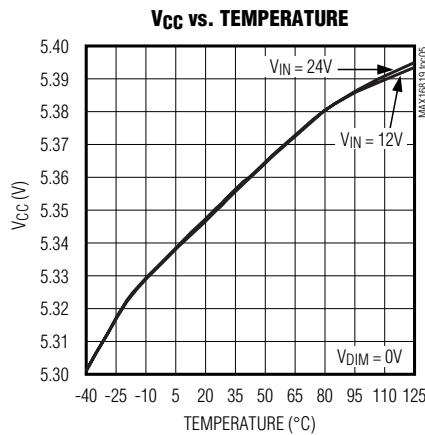
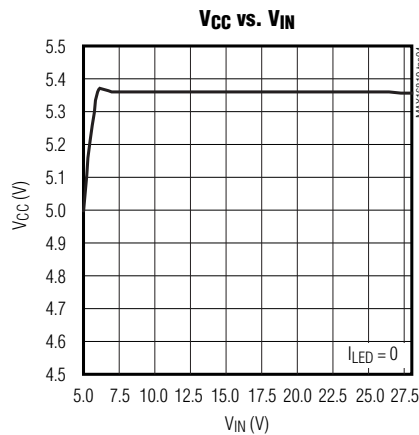
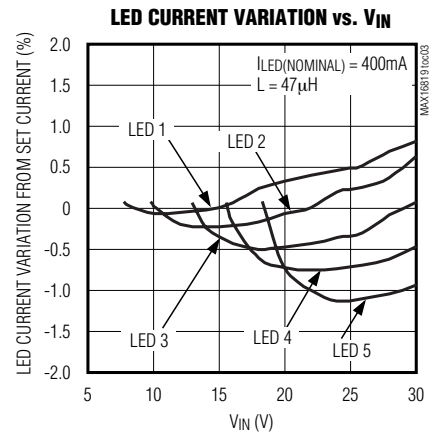
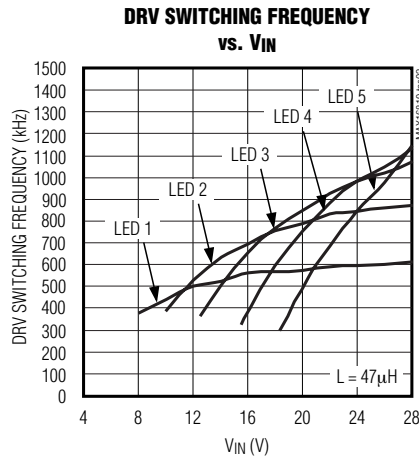
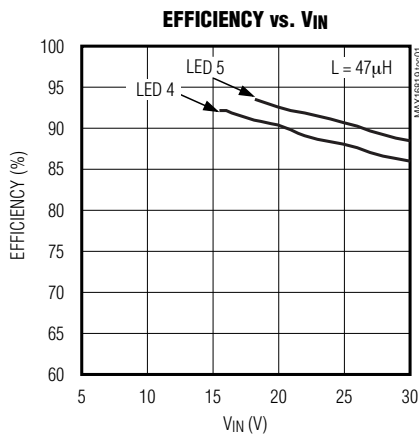

# 2MHz High-Brightness LED Drivers with High-Side Current Sense and 5000:1 Dimming

## Typical Operating Characteristics (continued)

( $V_{IN} = V_{DIM} = 12V$ ,  $C_{VCC} = 1\mu F$ ,  $R_{SENSE} = 0.5\Omega$  connected between IN and CSN. Typical values at  $T_A = +25^\circ C$ , unless otherwise noted.)

MAX16819/MAX16820

**PWM DIMMING AT 200Hz  
(1% DUTY CYCLE)**

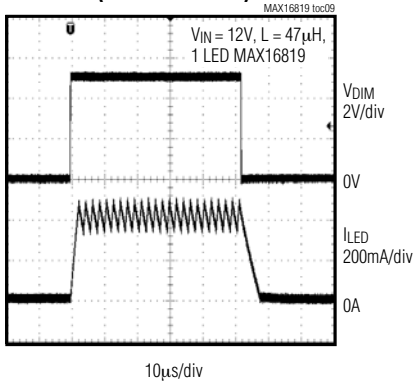

**PWM DIMMING EXPANDED  
(50% DUTY CYCLE)**

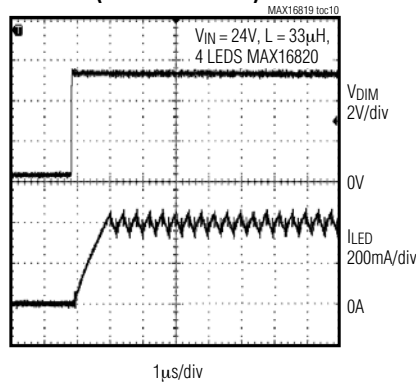

**PWM DIMMING EXPANDED  
(50% DUTY CYCLE)**

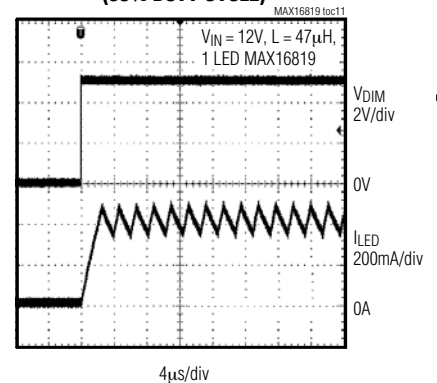

**PWM DIMMING AT 20kHz  
(10% DUTY CYCLE)**

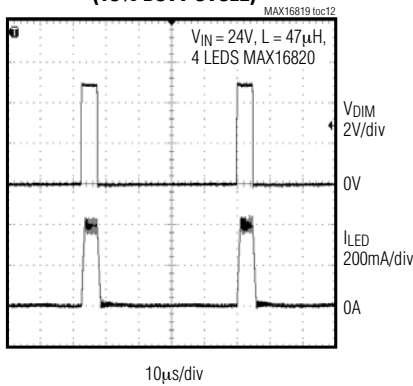

**PWM DIMMING AT 20kHz  
(90% DUTY CYCLE)**

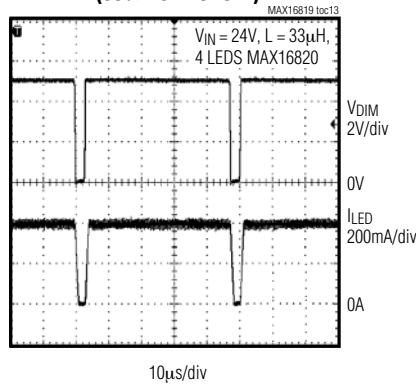

**$I_{LED}$  VARIATION vs. TEMPERATURE**

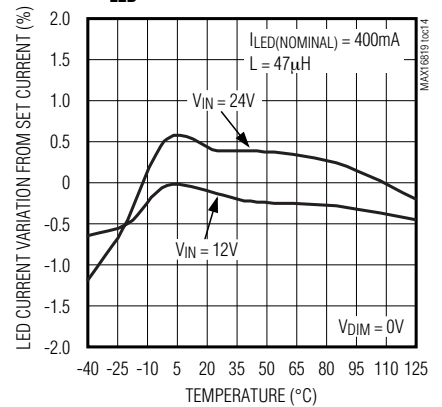

# 2MHz High-Brightness LED Drivers with High-Side Current Sense and 5000:1 Dimming

## Pin Description

PIN	NAME	FUNCTION
1	IN	Positive Supply Voltage Input. Bypass with a 1 $\mu$ F or higher value capacitor to GND.
2	CSN	Current-Sense Input
3	DIM	Logic-Level Dimming Input. Drive DIM low to turn off the current regulator. Drive DIM high to enable the current regulator.
4	GND	Ground
5	DRV	Gate Drive Output. Connect to the gate of an external n-channel MOSFET.
6	V <sub>CC</sub>	Voltage Regulator Output. Connect a 1 $\mu$ F capacitor from V <sub>CC</sub> to GND.
EP	—	Exposed Paddle. Connect to a large-area ground plane for improved power dissipation. Do not use as the only ground connection for the device.

## Functional Diagram

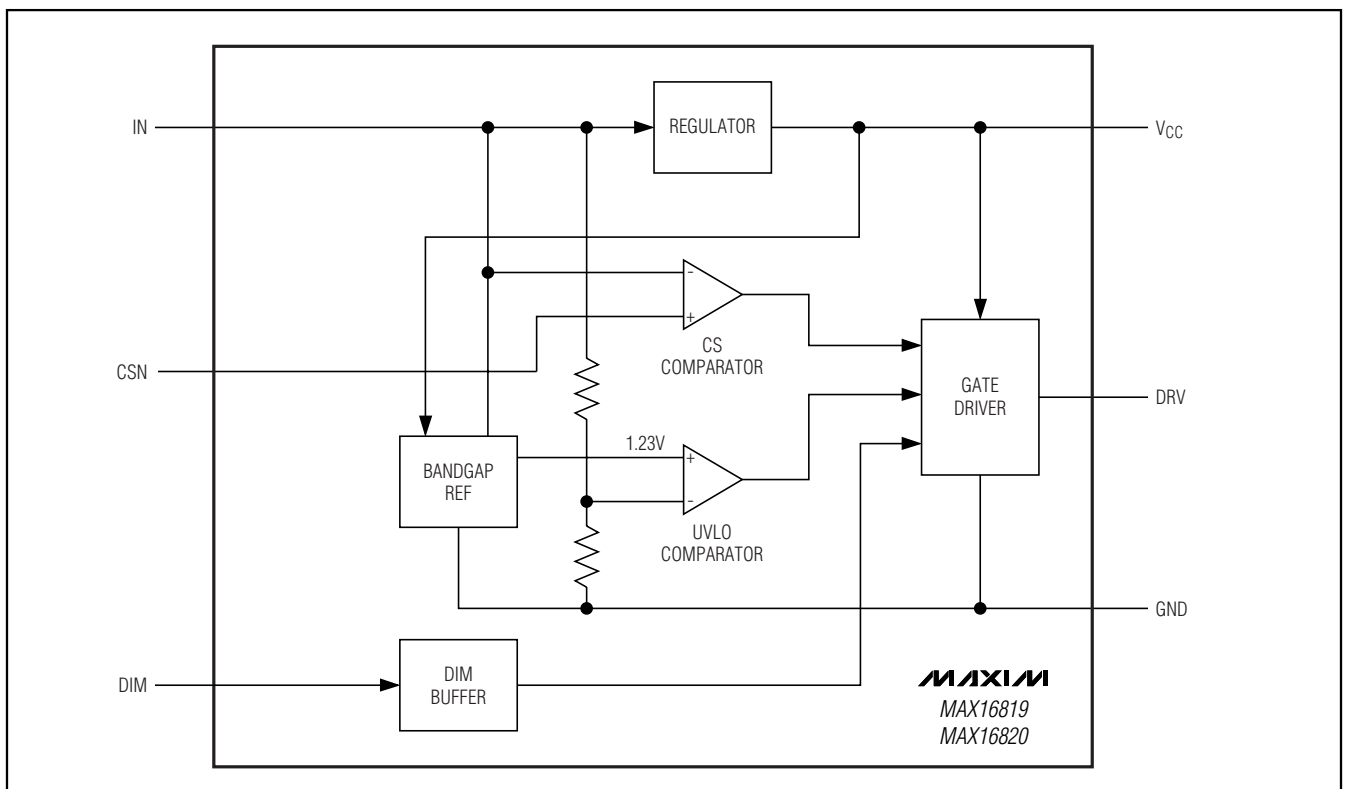

## Detailed Description

The MAX16819/MAX16820 are step-down, constant-current, high-brightness LED (HB LED) drivers. These devices operate from a 4.5V to 28V input voltage range and provide up to 0.5A of source and 1A of sink drive capability to the gate of an external MOSFET. A high-side current-sense resistor sets the output current and

a dedicated PWM dimming input (DIM) allows for a wide range of independent pulsed dimming.

The high-side current-sensing scheme and on-board current-setting circuitry minimize the number of external components while delivering LED current with a  $\pm 5\%$  accuracy, using a 1% sense resistor. See the *Functional Diagram*.

# 2MHz High-Brightness LED Drivers with High-Side Current Sense and 5000:1 Dimming

## Undervoltage Lockout (UVLO)

The MAX16819/MAX16820 include a 4.5V undervoltage lockout (UVLO) with 500mV hysteresis. When  $V_{IN}$  falls below 4.5V, DRV goes low, turning off the external n-channel MOSFET. DRV goes high once  $V_{IN}$  is 5V or higher.

## 5V Regulator

$V_{CC}$  is the output of a 5V regulator capable of sourcing 10mA. Bypass  $V_{CC}$  to GND with a 1 $\mu$ F capacitor.

## DIM Input

The MAX16819/MAX16820 allow dimming with a PWM signal at the DIM input. A logic level below 0.6V at DIM forces the MAX16819/MAX16820's DRV output low, turning off the LED current. To turn the LED current on, the logic level at DIM must be at least 2.8V.

## Applications Information

### Selecting $R_{SENSE}$ to Set the LED Current

The MAX16819/MAX16820 feature a programmable LED current using a resistor connected between IN and CSN. Use the following equation to calculate the sense resistor:

$$R_{SENSE}(\Omega) = \frac{1}{2} \frac{(V_{SNSHI} + V_{SNSLO})(V)}{I_{LED}(A)}$$

For the values of  $V_{SNSHI}$  and  $V_{SNSLO}$ , see the *Electrical Characteristics*.

### Current Regulator Operation

The MAX16819/MAX16820 regulate the LED output current using an input comparator with hysteresis (Figure 1). As the current through the inductor ramps up and the voltage across the sense resistor reaches the upper threshold, the voltage at DRV goes low, turning off the external MOSFET. The MOSFET turns on again when the inductor current ramps down through the freewheeling diode until the voltage across the sense resistor equals the lower threshold. Use the following equation to determine the operating frequency:

$$f_{SW} = \frac{(V_{IN} - n \times V_{LED}) \times n \times V_{LED} \times R_{SENSE}}{V_{IN} \times \Delta V \times L}$$

where  $n$  = number of LEDs,  $V_{LED}$  = forward voltage drop of one LED, and  $\Delta V = (V_{SNSHI} - V_{SNSLO})$ .

For proper component selection, please use the design tool available at: <http://www.maxim-ic.com/MAX16819-20-Tool>.

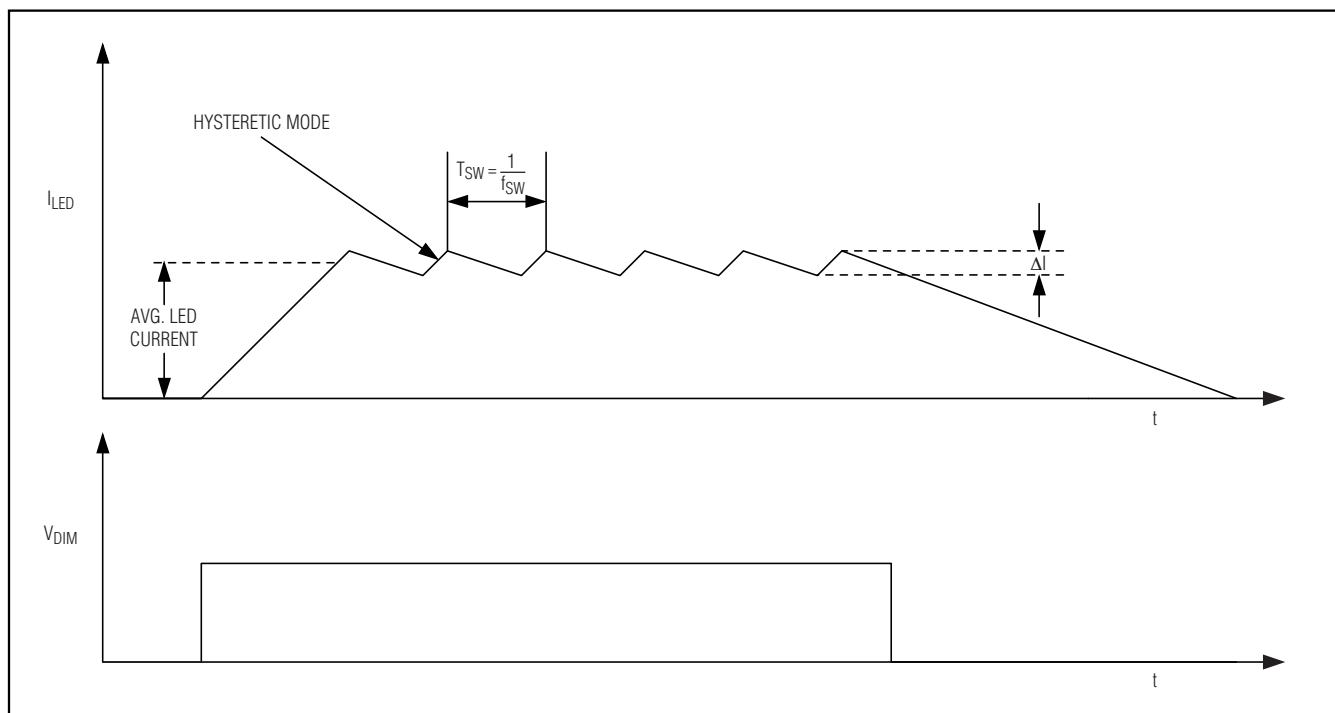

Figure 1. Current Regulator Operation

# 2MHz High-Brightness LED Drivers with High-Side Current Sense and 5000:1 Dimming

## **MOSFET Selection**

The MAX16819/MAX16820's gate driver is capable of sourcing 0.5A and sinking 1A of current. MOSFET selection is based on the maximum input operating voltage  $V_{IN}$ , output current  $I_{LED}$ , and operating switching frequency. Choose a MOSFET that has a higher breakdown voltage than the maximum operation voltage, low  $R_{DS(ON)}$ , and low total charge for better efficiency. MOSFET threshold voltage must be adequate if operated at the low end of the input-voltage operating range.

## **Freewheeling Diode Selection**

The forward voltage of the freewheeling diode should be as low as possible for better efficiency. A Schottky diode is a good choice as long as the breakdown voltage is high enough to withstand the maximum operating voltage.

The forward current rating of the diode must be at least equal to the maximum LED current.

## **LED Current Ripple**

The LED current ripple is equal to the inductor current ripple. In cases when a lower LED current ripple is needed, a capacitor can be placed across the LED terminals.

## **PCB Layout Guidelines**

Careful PCB layout is critical to achieve low switching losses and stable operation. Use a multilayer board whenever possible for better noise immunity. Minimize ground noise by connecting high-current ground returns, the input bypass-capacitor ground lead, and the output-filter ground lead to a single point (star ground configuration). In normal operation, there are two power loops. One is formed when the MOSFET is on and the high current flows through IN— $R_{SENSE}$ —LEDs—Inductor—MOSFET—GND. The other loop is formed when the MOSFET is off when the high current circulates through  $R_{SENSE}$ —LEDs—Inductor—freewheeling diode. To minimize noise interaction, each loop area should be as small as possible.

Place  $R_{SENSE}$  as close as possible to the input filter and IN. For better noise immunity, a Kelvin connection is strongly recommended between CSN and  $R_{SENSE}$ . Connect the exposed paddle to a large-area ground plane for improved power dissipation.

## **Chip Information**

PROCESS: BiCMOS



# 2MHz High-Brightness LED Drivers with High-Side Current Sense and 5000:1 Dimming

## Package Information

(The package drawing(s) in this data sheet may not reflect the most current specifications. For the latest package outline information go to [www.maxim-ic.com/packages](http://www.maxim-ic.com/packages).)

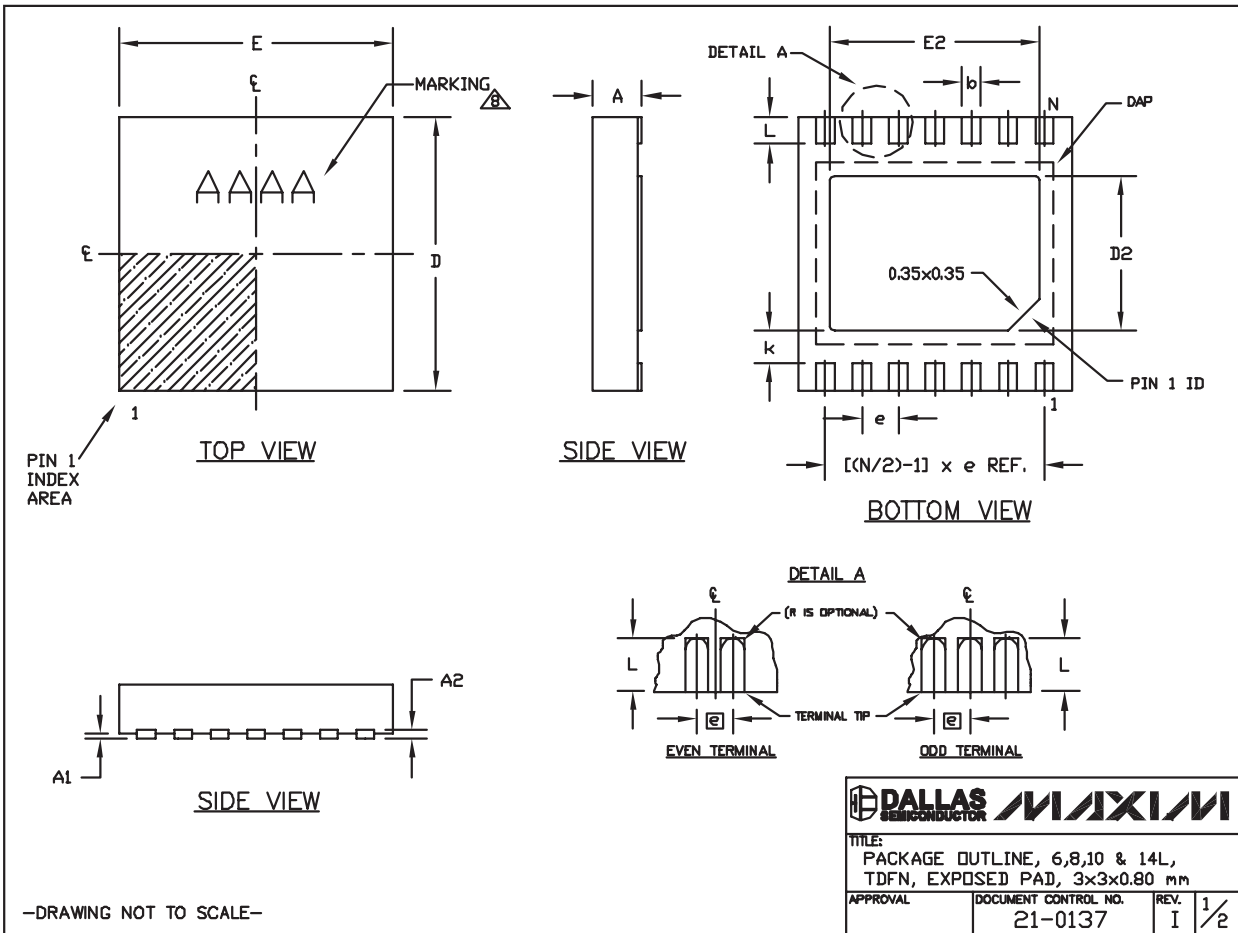

# 2MHz High-Brightness LED Drivers with High-Side Current Sense and 5000:1 Dimming

## Package Information (continued)

(The package drawing(s) in this data sheet may not reflect the most current specifications. For the latest package outline information go to [www.maxim-ic.com/packages](http://www.maxim-ic.com/packages).)

COMMON DIMENSIONS		
SYMBOL	MIN.	MAX.
A	0.70	0.80
D	2.90	3.10
E	2.90	3.10
A1	0.00	0.05
L	0.20	0.40
k	0.25 MIN.	
A2	0.20 REF.	

PACKAGE VARIATIONS								
PKG. CODE	N	D2	E2	e	JEDEC SPEC	b	[(N/2)-1] x e	
T633-2	6	1.50±0.10	2.30±0.10	0.95 BSC	MO229 / WEEA	0.40±0.05	1.90 REF	
T833-2	8	1.50±0.10	2.30±0.10	0.65 BSC	MO229 / WEEC	0.30±0.05	1.95 REF	
T833-3	8	1.50±0.10	2.30±0.10	0.65 BSC	MO229 / WEEC	0.30±0.05	1.95 REF	
T1033-1	10	1.50±0.10	2.30±0.10	0.50 BSC	MO229 / WEED-3	0.25±0.05	2.00 REF	
T1033-2	10	1.50±0.10	2.30±0.10	0.50 BSC	MO229 / WEED-3	0.25±0.05	2.00 REF	
T1433-1	14	1.70±0.10	2.30±0.10	0.40 BSC	----	0.20±0.05	2.40 REF	
T1433-2	14	1.70±0.10	2.30±0.10	0.40 BSC	----	0.20±0.05	2.40 REF	

### NOTES:

- ALL DIMENSIONS ARE IN mm. ANGLES IN DEGREES.
- COPLANARITY SHALL NOT EXCEED 0.08 mm.
- WARPAGE SHALL NOT EXCEED 0.10 mm.
- PACKAGE LENGTH/PACKAGE WIDTH ARE CONSIDERED AS SPECIAL CHARACTERISTIC(S).
- DRAWING CONFORMS TO JEDEC MO229, EXCEPT DIMENSIONS "D2" AND "E2", AND T1433-1 & T1433-2.
- "N" IS THE TOTAL NUMBER OF LEADS.
- NUMBER OF LEADS SHOWN ARE FOR REFERENCE ONLY.
-  MARKING IS FOR PACKAGE ORIENTATION REFERENCE ONLY.

—DRAWING NOT TO SCALE—

		
TITLE: PACKAGE OUTLINE, 6,8,10 & 14L, TDFN, EXPOSED PAD, 3x3x0.80 mm		
APPROVAL	DOCUMENT CONTROL NO. 21-0137	REV. I 2/2

## Revision History

Pages changed at Rev 1: 1, 4, 10

Maxim cannot assume responsibility for use of any circuitry other than circuitry entirely embodied in a Maxim product. No circuit patent licenses are implied. Maxim reserves the right to change the circuitry and specifications without notice at any time.

10 **Maxim Integrated Products, 120 San Gabriel Drive, Sunnyvale, CA 94086 408-737-7600**

© 2007 Maxim Integrated Products

**MAXIM** is a registered trademark of Maxim Integrated Products, Inc.

MAX16819/MAX16820